

BROADCAST NEWS

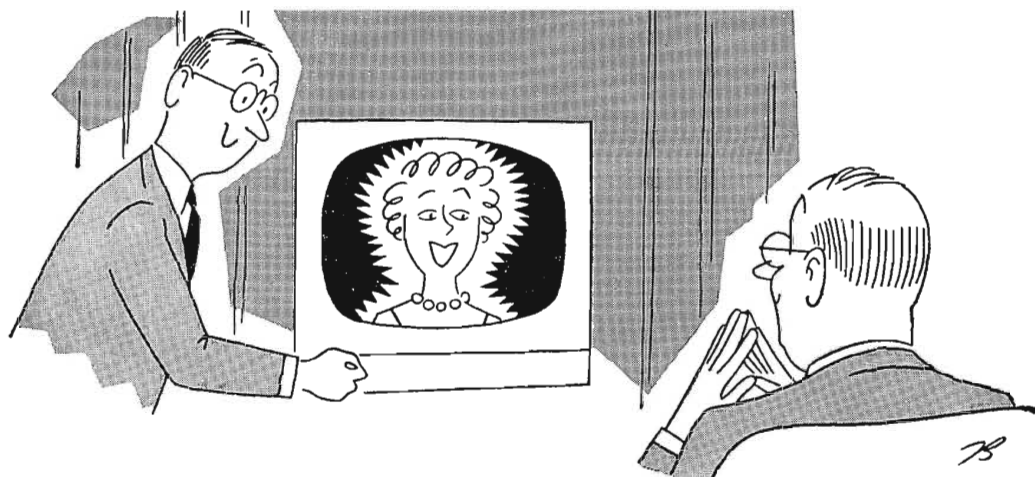

VOL. No. 88 APRIL, 1956





How adequate house monitoring can **HELP YOU** sales-wise

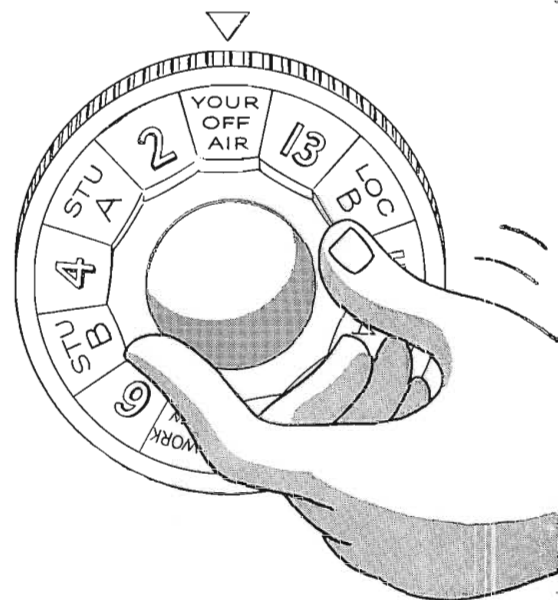

WHEN a client visits your office, are you able to punch up any on-air signal . . . color or monochrome . . . on the channel selector of your nearest TV receiver? Or, are you limited when it comes to station monitoring? Wouldn't it give you a "selling aid" to be able to go to your channel selector and receive:

- a. Any rehearsal . . . live program . . . preview of sponsor's film
- b. Any on-air show . . . from studio . . . from transmitter
- c. Other local stations' off-air signals . . .

A sales plus in the Sales Manager's office

With a modern RCA signal distribution system you can flip the switch and bring in whatever your customer requests. Handles all studios in rehearsal, on-air signal, or any local station. Up to seven channels are available . . . tailored to your own special requirements . . . for monochrome and color.

How the house monitoring system works

Local and remote signals (audio and video) are fed to a closed circuit transmitter of the monitran type. An RCA monitran handles local signals—one monitran is used for each signal.

The output of the monitran is then fed to an RF amplifier. Off-air signals go directly to the input of the amplifier. All signals are fed via a single coax cable to any standard TV receiver. In the RCA system, the receiver need not be "jeeped." No expensive video monitors are required since standard receivers are used.

Fully rated for color

Whether for color or monochrome you'll find the RCA house distribution system—low in cost, easy to install and operate, and fully satisfactory for picture quality.

Your RCA Broadcast Sales representative will be glad to advise you on the equipment best suited to your needs.

SEVEN PICTURE SOURCES TO ANY LOCATION VIA A SINGLE CABLE

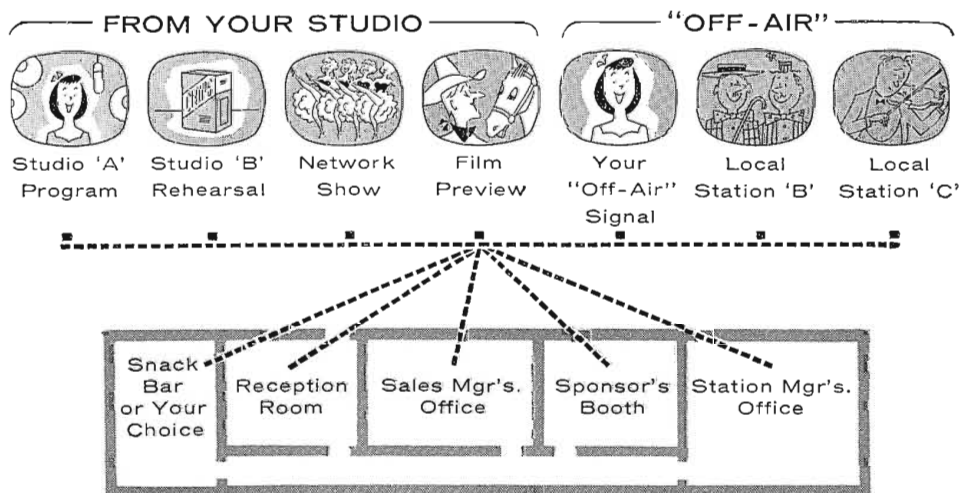

Ask
the Engineer
—he knows



**RADIO CORPORATION
of AMERICA**

ENGINEERING PRODUCTS DIVISION • CAMDEN, N.J.

In Canada: RCA VICTOR Company Limited, Montreal

Vol. No. 88

April, 1956

BROADCAST NEWS

published by

RADIO CORPORATION OF AMERICA
BROADCAST & TELEVISION EQUIPMENT DEPARTMENT
CAMDEN, NEW JERSEY

PRICE *In continental U.S.A. --- \$4.00 for 12 issues*
In other countries ----- \$5.00 for 12 issues

CONTENTS

THE BC-3B . . . A NEW DELUXE CONSOLETTA . <i>by E. J. Meehan</i>	8
DISPLAY OF LATEST RCA EQUIPMENTS AT NARTB	10
WDMJ TO INSTALL 170-MILE RCA MICROWAVE SYSTEM	12
COLOR TV "STUDIO-ON-WHEELS" PURCHASED BY SMITH, KLINE & FRENCH FOR MEDICAL DEMONSTRATIONS	12
NEW PORTLAND VHF STATION WILL BE FIRST TO INSTALL RCA 100-KW TRANSMITTER	13
KOMO-TV ANNOUNCES PLAN FOR FAST-PROCESSING OF COLOR FILM	14
RCA 5-KW AM TRANSMITTERS SET STANDARDS FOR HIGH-FIDELITY PERFORMANCE	18
WNBQ STARTS ALL-COLOR OPERATION	22
KMTV BRINGS COLOR TV TO OMAHA . . . <i>by R. J. Schroeder</i> <i>and P. A. Greenmeyer</i>	26
WCAU-TV COVERS PHILADELPHIA MUMMERS PARADE IN COLOR	48
A MOBILE UNIT FOR COLOR TELEVISION BROADCASTING AND CLOSED-CIRCUIT APPLICATIONS . . . <i>by Henry H. Klerx</i>	56
ANNUAL AM MEETING BRINGS RCA SALES REPRESENTATIVES TOGETHER	62

"RCA PIONEERED AND DEVELOPED COMPATIBLE COLOR TELEVISION"

RCA AMPLI

RCA *Ampliphase* RCA

**50-KW AM
AIR COOLED!**

**New RCA 50-kilowatt
AM Transmitter BTA-50G**

**DESIGNED WITH
AMPLIPHASE MODULATION**

HOW IT WORKS!

To produce phase-to-amplitude modulation in the BTA-50G, a carrier wave is developed by a common exciter. This carrier wave is then split and fed to two separate amplifier chains through phase-shift networks that establish a carrier phase difference. These two signals are controlled so that each maintains a prescribed phase relationship with the other in accordance with the intensity of modulating signal. This controlled phase relationship enables the separate 25-kilowatt amplifiers, when feeding their outputs into a combining circuit, to produce a maximum level 50-kilowatt amplitude modulated signal.

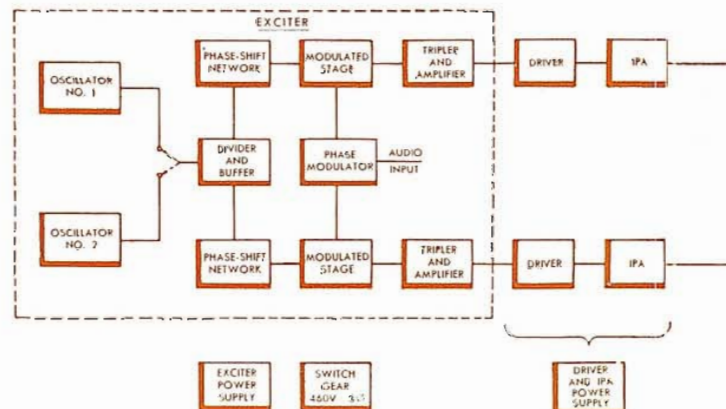

SIMPLIFIED BLOCK DIAGRAM—BTA-50G TRANSMITTER

PHASE

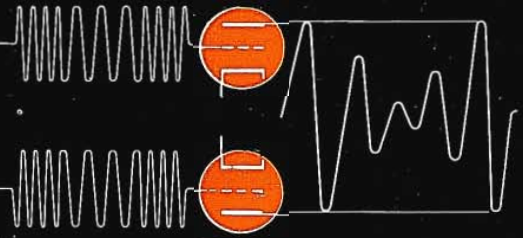

A new concept in AM Broadcasting!

... introduced in RCA's revolutionary new 50-KW AM transmitter

Here is the most significant forward step in AM transmitters since RCA introduced high level modulation—an entirely new 50-KW transmitter using Ampliphase Modulation. Newest and finest in RCA's long line of distinguished AM transmitter designs, it is further proof of RCA leadership in the broadcast equipment field.

Ampliphase cuts transmitter floor space and operating costs by substantial margins. The BTA-50G is housed in four cubicles. It does away with half of present power tubes . . . along with bulky components such as modulation transformers,

reactors and accessories. It requires no underfloor trenches, costly water cooling systems, external blowers. And there's no lost air-time—because the 50-KW Ampliphase is remarkably easy to install while your present transmitter is in operation. Then, in most cases, you may keep your old unit as a stand-by.

For complete technical details . . . and for information on the surprisingly low price . . . call your RCA Broadcast Sales Representative. In Canada, write RCA VICTOR Company Limited, Montreal.

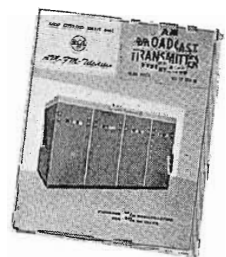

FACTS ABOUT RCA'S NEW 50-KW AM

- Takes less than 80 square feet of floor space. No underfloor trenches required.
- Lowest operating cost of any 50-KW AM transmitter.
- Half the tube cost of other 50-KW AM transmitters.
- Uses famous Long-Life RCA 5671 P.A. tubes.
- No Modulation transformer required.
- Completely air-cooled with internal blowers—no air intake ducts necessary.
- Low distortion, excellent frequency response.
- Splatter-free modulation provided by new Ampliphase design.
- Designed to permit remote-control operation.
- New simplified circuitry. Extremely stable operation.

PIONEERS IN AM BROADCASTING FOR OVER 25 YEARS



RADIO CORPORATION of AMERICA
ENGINEERING PRODUCTS DIVISION

CAMDEN, N.J.

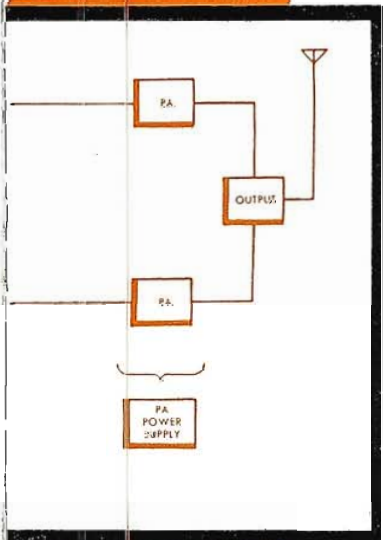
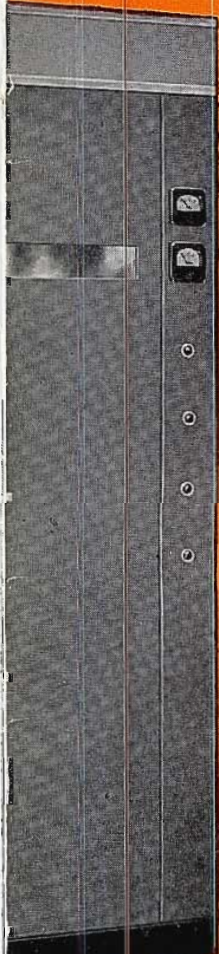

how **WHIS-TV** got

RCA 3-HOP MICROWAVE SYSTEM BRINGS NETWORK OVER

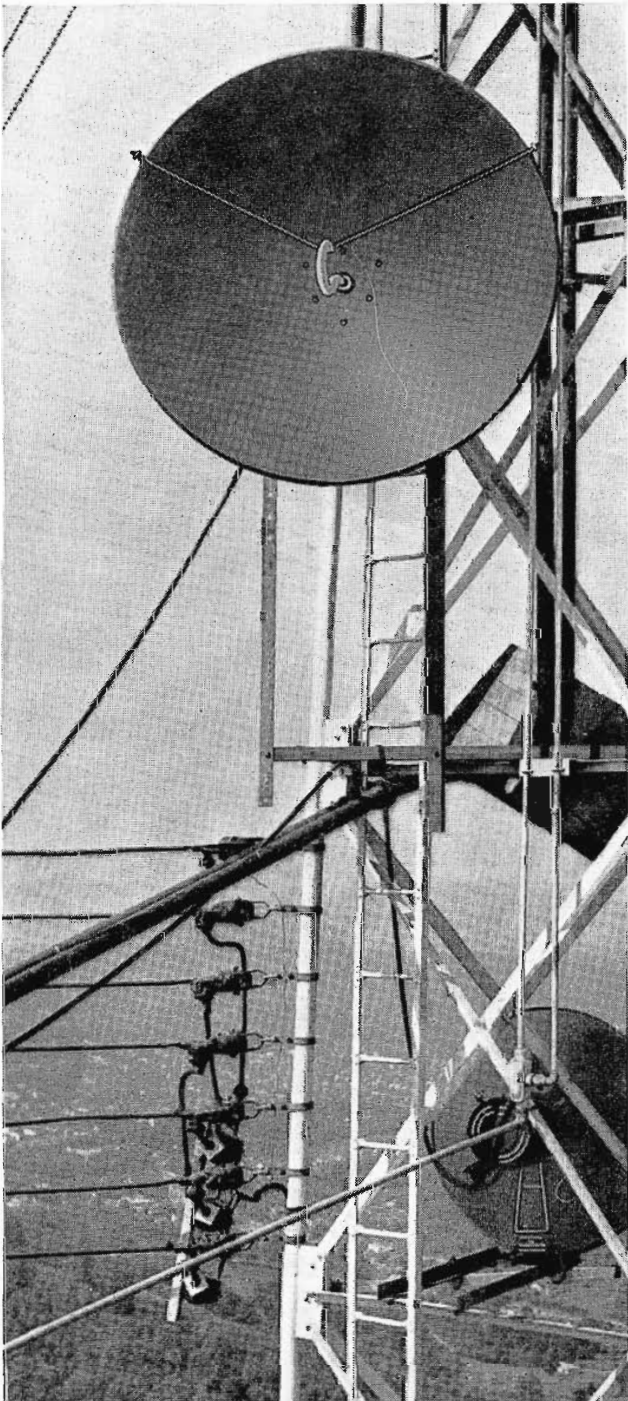

If you want network programs but no common carrier facilities exist, what do you do? Faced with this problem, Jim and Hugh Shott of Station WHIS-TV, Bluefield, W. Va., decided to install their own microwave relay system to bring NBC programs from Roanoke, Va.—a distance of some 70 air line miles. For this use they chose the new RCA TVM-1A Microwave. Administrative Technical Director for WHIS-TV, Pat Flanagan, laid out the 3-hop system, designed relay towers and buildings and installed the RCA equipment.

PRETESTING THE SYSTEM—Prior to the installation, RCA Service Company bench-tested the radio relay equipment and each piece was marked. Then the system was set up as a complete 3-hop system in the studio and tested. This test took two days. After that it was transported to relay sites to Roanoke, and to the terminal site for installation in rack and towers. Unitized chassis and simplicity of construction facilitated installation.

INSTALLATION OF EQUIPMENT—Final setups at terminal and relay points were made in four days by Flanagan and his staff, using two crews of three men each. On the fourth day, in Bluefield, the signal was received at the terminal and final adjustment of antennas was made. Final tune-up and final alignment of the system was performed by an RCA Service Company engineer. In the first month of operation only one hour was lost even though personnel were unfamiliar with the new equipment.

UNATTENDED OPERATION—This RCA Microwave System is designed for automatic operation, with no personnel

Parabolic reflectors on WHIS-TV transmitter tower. The one in front receives network programs from relay point; the other picks up signals from the downtown studios.

RCA PIONEERED AND DEVELOPED COMPATIBLE COLOR TV

network... fast!

70 MILES OF MOUNTAINOUS TERRAIN

at relay sites. When the NBC network signal is received at Roanoke, it is fed to the transmitter which is turned on by a local technician. The beamed signal then starts the next transmitter, and so on all down the line. Should anything go wrong, the system will shut itself down. This is accomplished by means of a solenoid-operated radiation switch. When the fault is cleared, the system automatically starts up by means of the network signal.

POINT OF ORIGIN—The microwave connects into existing AT&T circuits in Roanoke. Arrangements were made with Station WDBJ in Roanoke to lease space for the equipment. Special advantages of RCA TVM-1A Microwave include:

HIGH POWER—An increase of 10 in transmitter power and 3 db in receiver noise figure over previous models. 20 times the fading margin of the popular RCA TTR-TRR series, for greater propagational reliability.

SOUND DIPLEXING—High Quality audio channel for simultaneous transmission of sound along with picture information. This channel exceeds FCC requirements for a studio-to-transmitter link.

TRANSMITTER PICTURE MONITORING—Assures high quality "air" signal for monitoring at transmitter. Simplifies trouble shooting procedures. Also extremely useful in operation of unattended repeater stations.

For descriptive literature on this newest of Microwave Systems or for help in planning your microwave setup, see your RCA Broadcast Sales Representative.



WHIS-TV Administration and Technical Director, "Pat" Flanagan.

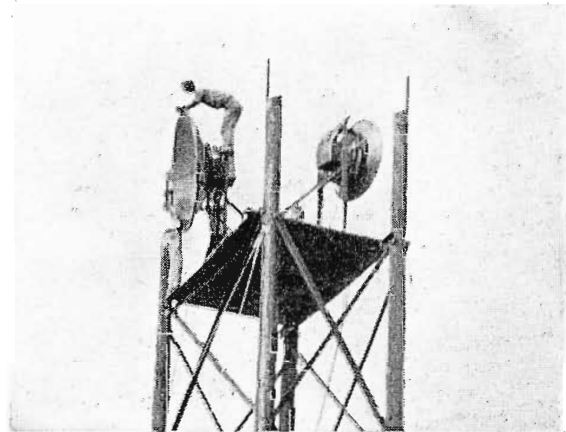

Relay tower on Poor Mountain. The men on tower are making final adjustments.

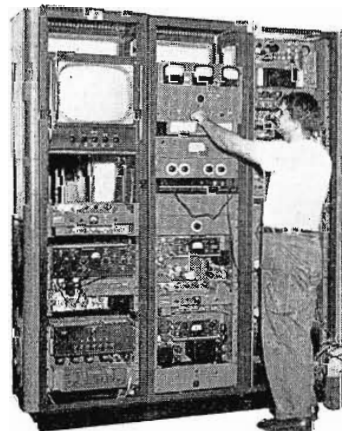

Microwave Control Rack.

Microwave reflector with transmitter on back, at Roanoke, Virginia.

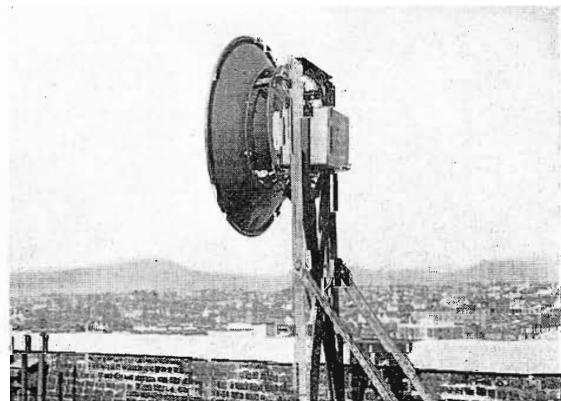

RADIO CORPORATION of AMERICA

BROADCAST AND TELEVISION EQUIPMENT, CAMDEN, N. J.

It's Here! RCA's Production

1 
**Performs
4 Functions**



MORE EFFICIENT

"All-in-one" Processing Amplifier combines the signal processing functions of previous channel amplifier, gamma corrector, shading generator, and monitor auxiliary.

Only 
1 1/3 Racks

COMPACT

The new equipment utilizes only 100 inches of rack space; can be mounted in only 1 1/3 racks for efficient, compact installation.

1/3 Less Tubes

LOW OPERATING COST

Requires half the ac power needs of conventional equipment and permits elimination of 50% of former dc power supplies. Uses 9 less rack-mounted units, and 134 fewer tubes — conservatively operated for extended life.

FAST SETUP

FAST SETUP

Centralized controls minimize setup time, require but a single operator for control functions. In addition, over-all stability, improvement in camera performance and picture quality are assured.

.. with the revolutionary

all-electronic

processing amplifier

and only 2 operating controls
for entire camera chain

12-Page Descriptive Brochure
Available on Request.

RCA TK-41 TYPE COLOR CAMERA

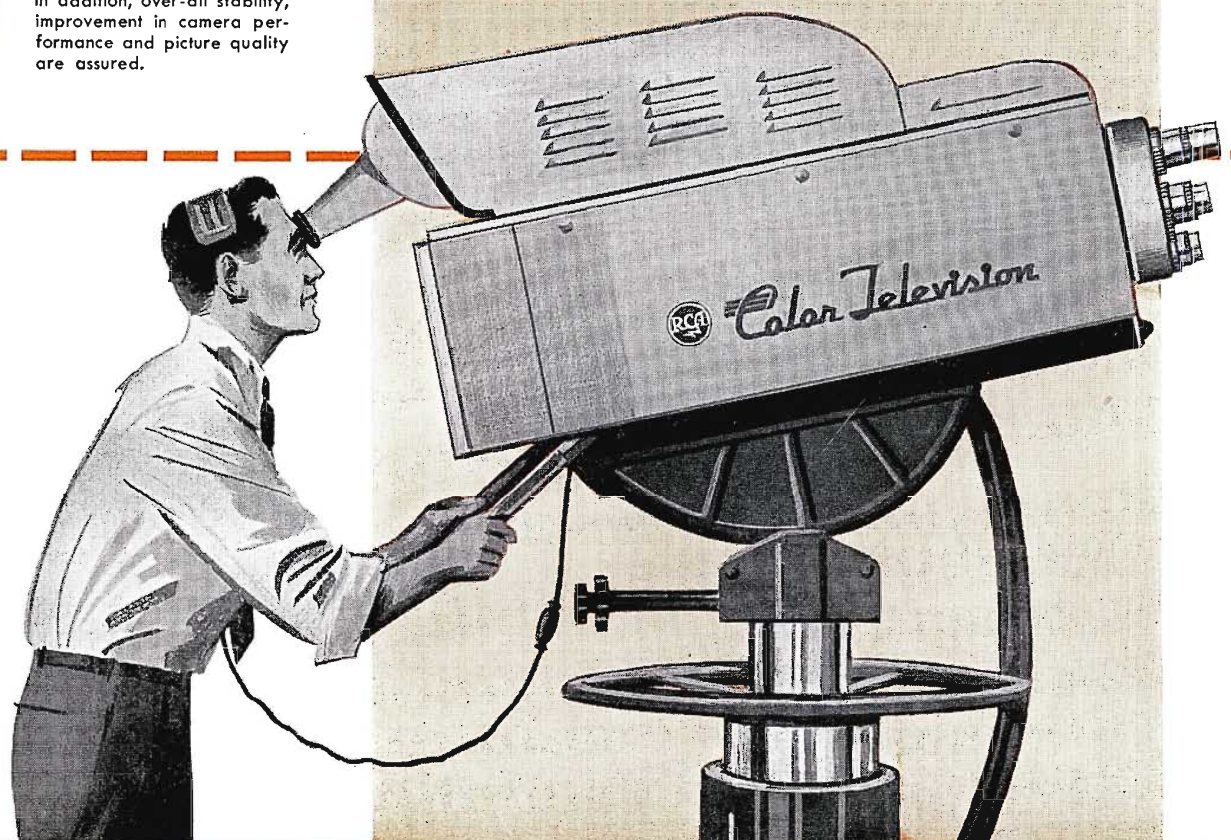

COLOR CAMERA TV EQUIPMENT

No need to wait any longer for *production* live color TV equipment! RCA has it now . . . a complete new TK-41 Color Camera chain with new all-in-one Processing Amplifier, which combines four major functions in one. It not only provides important savings in components, floor space and operating costs, but assures highest quality at lowest expense.

This is the complete color camera TV equipment that television stations are now using in their swing to color, or in expanding their color facilities. For complete technical information, call your RCA Broadcast Sales representative. In Canada, write RCA VICTOR Company Limited, Montreal.

RCA Pioneered and Developed Compatible
Color Television



RADIO CORPORATION of AMERICA
BROADCAST AND TELEVISION EQUIPMENT CAMDEN, N.J.

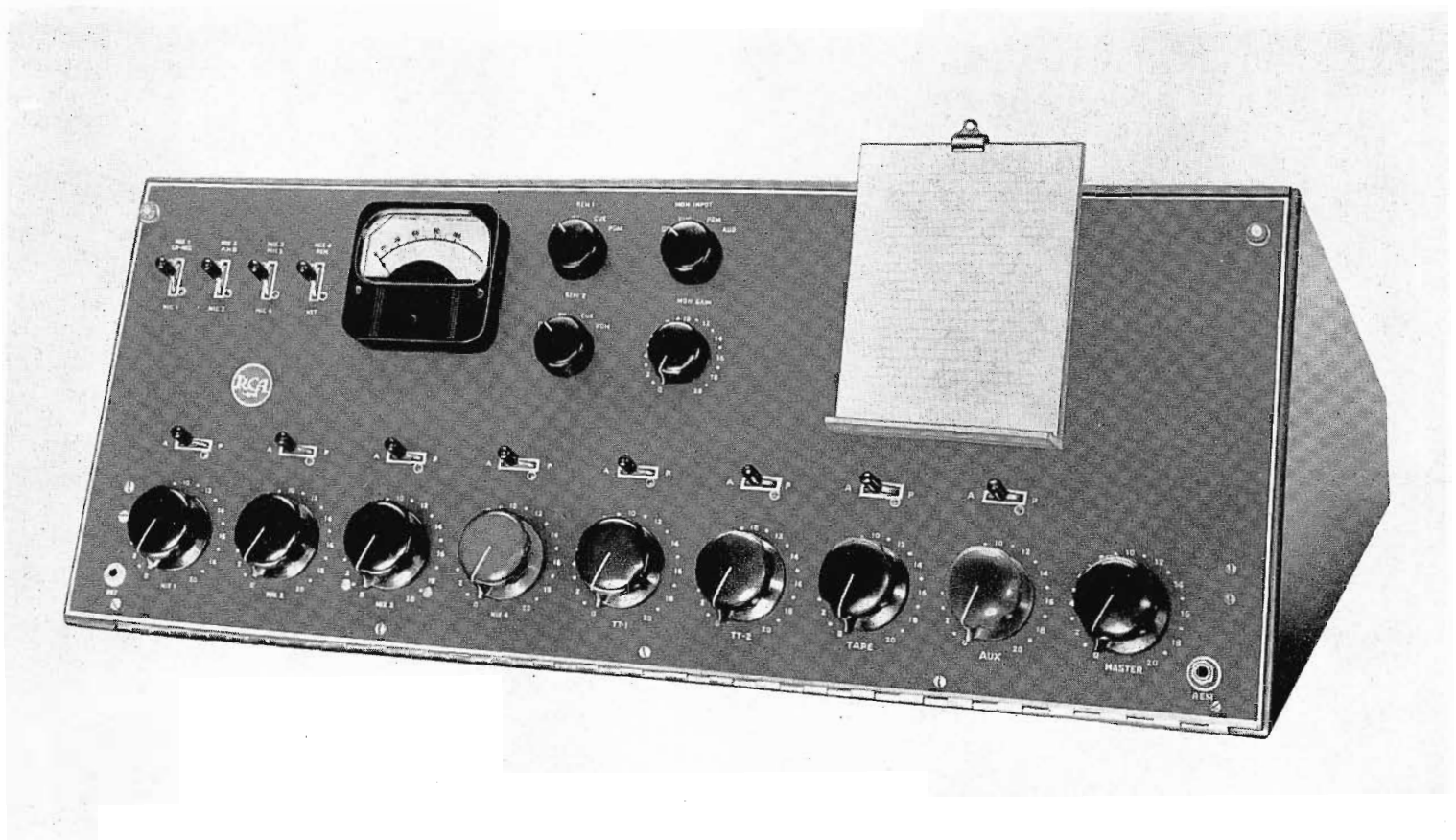

The BC-3B audio console . . . a standard-size unit with power supplies, monitoring amplifiers and speaker relays "built-in".

THE BC-3B . . . A NEW DELUXE CONSOLE

*Increased Facilities, Functional Styling and Modular-Construction
Featured in New General-Purpose Equipment*

The BC-3B is one of a "family" of three completely new audio consoles. The other two models, BC-5A and BC-6A were described in previous issues of BROADCAST NEWS.* However, a quick run-down of the facilities provided in the BC-5A and BC-6A are reviewed on the opposite page.

The new BC-3B console is a deluxe-type standard-size unit which provides complete facilities for most applications. Identical in size and shape to the BC-2B console, which it replaces, the new unit will handle six microphone inputs, two turn-

* "New Dual-Channel Console" BROADCAST NEWS No. 86, December, 1955. "A New Expandable Audio Console" BROADCAST NEWS No. 87, February, 1956.

by E. J. MEEHAN

**Sales Administrator, Broadcast and
Television Equipment Dept.**

table inputs, two remote lines, one network input, one tape input and one auxiliary position. The BC-3B will feed one program output at + 18 dbm, as well as two monitor speakers, one external monitor, two remote lines for cuing, plus turntable cue. Simultaneous mixing of any eight inputs is possible.

Three preamplifiers of the modular printed-wiring type are utilized, plus audition and program booster amplifiers, monitoring amplifier and line amplifier. Recom-

mended operating practice calls for inclusion of separate preamplifiers (such as the RCA Type BA-12A) at each turntable position. The unit control circuits include two 24-volt relays for control room and studio speaker and On-Air light operation which are controlled by microphone selector and program-audition switches.

The unit is entirely self-contained, and particular attention has been paid to control-position and functional layout. A convenient script-rack is located on the right side of the front panel to provide correct eye-level program material where combination-type operation is planned.

The BC-3B may be easily expanded by addition of the BCM-1A mixer console or the BC-5A to provide dual-channel operation. Styling of all units is uniform to provide proper matching, physically as well as electrically.

Performance-wise, the BC-3B meets or exceeds specifications of its illustrious predecessors. Harmonic distortion on program output is less than 0.5 per cent from 100 to 15,000 cps, 0.75 per cent at 50 cps and 1 per cent at 30 cps. On monitor output less than 0.5 per cent distortion is attained from 100 to 15,000 cps, with 1 per cent distortion at 50 cps.

Frequency response from 30 to 15,000 cps is flat within 1.5 db on the program channel and 2 db in the monitoring channel. Signal-to-noise ratio on the program channel with mixer and master gain controls set for 68 db gain is 68 db below + 18 dbm output. Overall gain of the program channel is 108 db, while audition channel gain is 125 db.

Use of modular-type printed-wiring construction in the BC-3B permits a new concept of uniformity and economy in construction and fabrication of this excellent new consolette. Volume production on modules common to all RCA consolettes, plus improved and simplified design characteristics makes possible increased input facilities at considerably lower cost than the predecessor BC-2B equipment.

Of special interest in the mechanical design are the improved positive-contact leaf-type switches which assure years of trouble-free, noiseless operation. The outstanding feature of the BC-3B as well as the BC-5A and BC-6A is the inclusion of power supplies, monitoring amplifiers and speaker relays within the console housing. Each model eliminates the need of "hunting" for a place to mount these items, reduces installation costs and gives you the widest choice of facilities ever offered. The summary of these consolette facilities is presented in the box at right.

SUMMARY OF FACILITIES IN THE THREE NEW AUDIO CONSOLETTES

BC-5A

(FOR THE SMALL OPERATION . . . BUT EXPANDABLE BY "PAIRING")

Nine Inputs—4 microphones, 2 turntables, 2 remote lines, 1 network or tape. 4 mixer positions. BUILT-IN POWER SUPPLY. Easily expanded for dual channel use by "pairing". Block building lends "custom touch" when paired with existing BC-2B's.

BC-3B

(MEDIUM SIZE . . . BUT WIDE CHOICE OF FACILITIES)

Thirteen Inputs—6 microphones, 2 turntables, 2 remote lines, 1 network, 2 utility inputs which may be used for additional turntables, tape, or as required. 8 mixer positions. BUILT-IN POWER SUPPLY. Easily expanded for dual channel use by pairing with BC-5A. Convenient script rack.

BC-6A

(FOR LARGER OPERATIONS . . . DUAL CHANNEL, SWITCHABLE TO SINGLE CHANNEL)

Twenty-Two Inputs—10 microphones, 2 turntables, 2 tape, 2 film, 5 remote lines, 1 network. DUAL OR SINGLE CHANNEL OPERATION with "split-mixer" faders. Master fader controls both channels simultaneously. Ideal for binaural broadcasting. 9 mixer positions. TWO BUILT-IN POWER SUPPLIES (one for each channel) for greater reliability. Two monitoring channels, one for program monitoring and talkback, one for cueing and feeding background to studios. Convenient script rack.

Simplified block diagram of the BC-3B Standard Consolette.

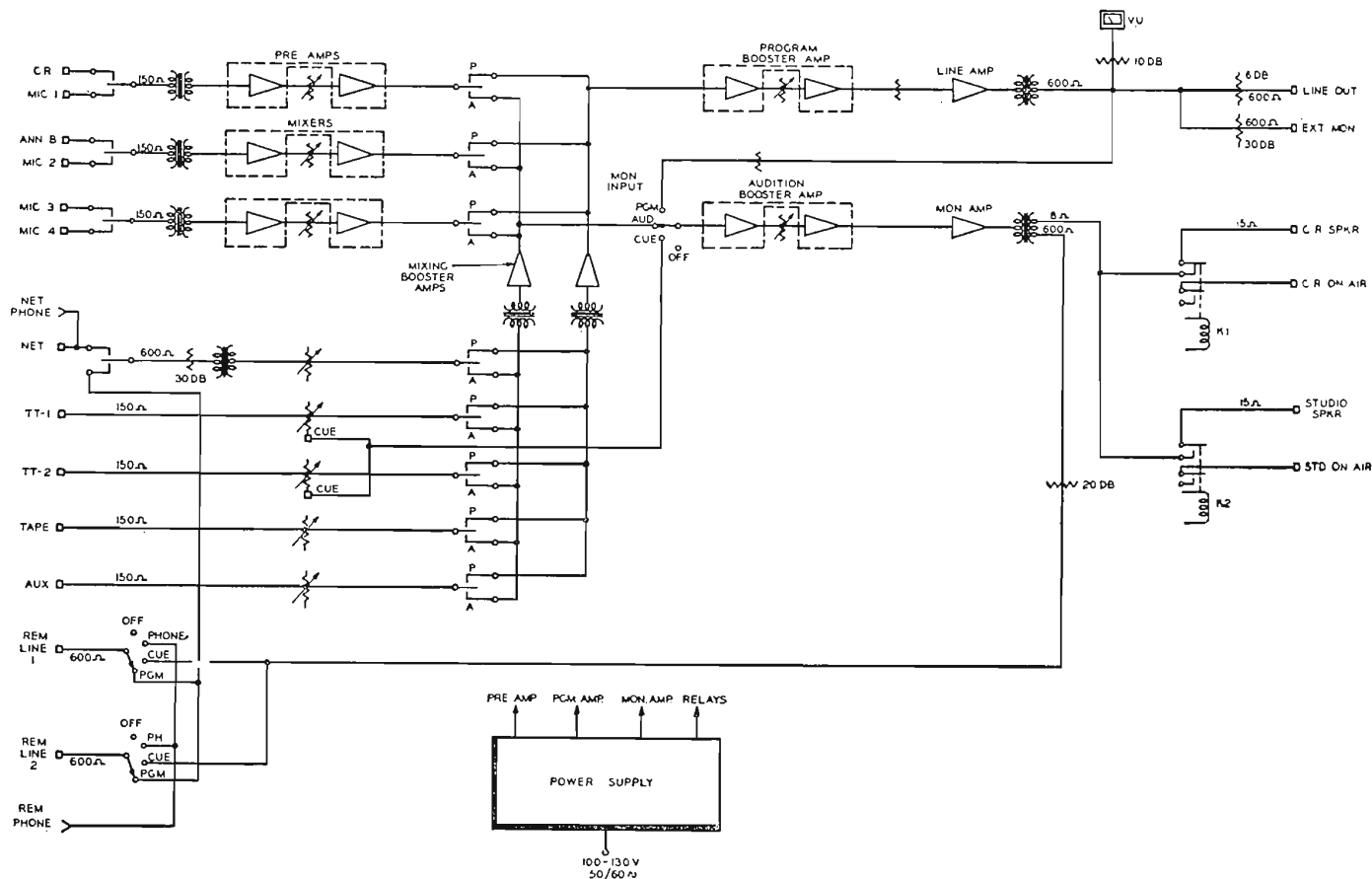

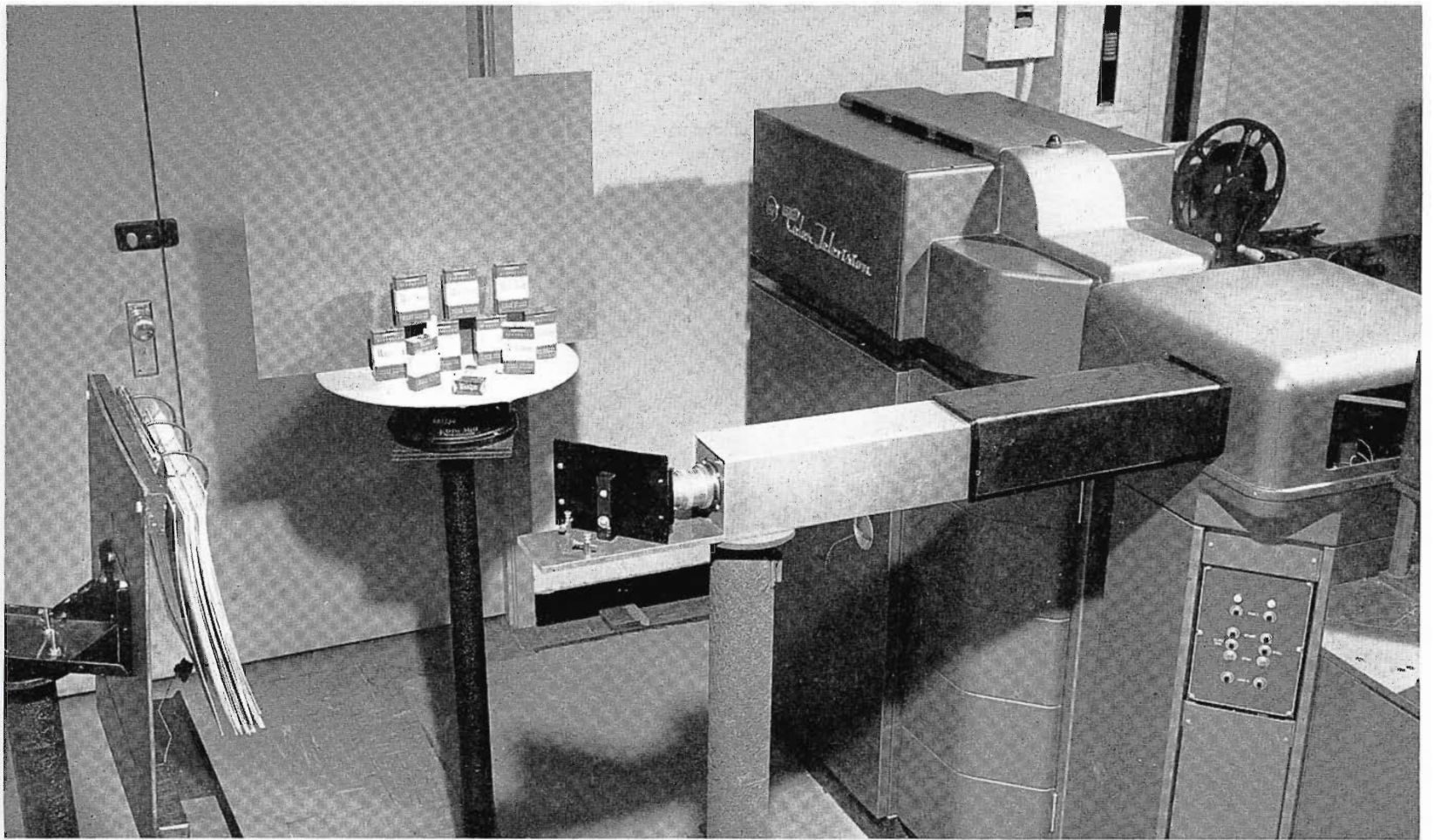
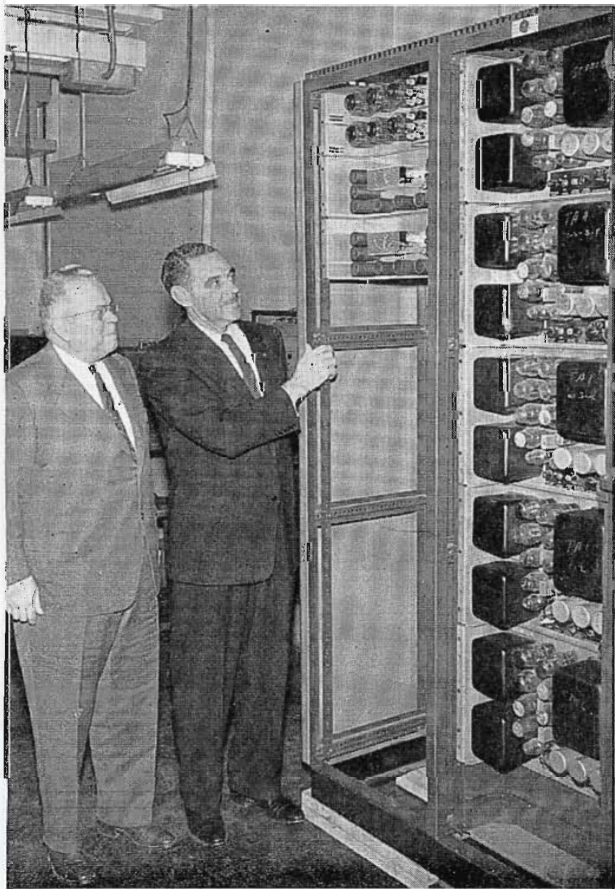

FIG. 1. Lens system added to RCA TK-26A 3-V Color Film Chain for pickup of live color commercials and color opaques.

DISPLAY OF LATEST RCA EQUIPMENTS AT NARTB



Latest advances in RCA broadcast equipment for television and radio stations will be on display at the 34th Annual NARTB Convention at the Conrad Hilton Hotel, Chicago, April 15 through 20. Among the major new equipments to be shown for the first time are a 6 kilowatt lowband television transmitter; a complete 50 kilowatt AM "Ampliphase" transmitter; and a low cost 1 kilowatt AM transmitter. Also to be shown are a newly designed family of three audio consolettes; a complete RCA house monitoring system and a new high-output power supply which greatly reduces rack space required for operation of television equipment. These will be displayed along with many other RCA equipments for radio and TV broadcast operations.

3-V Film System Features Live Action and Opaques

Live color commercials will be demonstrated on the 3-V Color Film System. An inexpensive extension lens adapts the basic 3-V system for live action and use with color opaques. Representative commercials using actual products will be demonstrated.

FIG. 2. Two new WP-15 power supplies are equivalent to a whole rack of five WP-33B's.

Large color opaques of artwork will be reproduced through the system to show picture quality and color fidelity.

In addition to facilities for live action and opaques, the complete 3-V system will include a TK-26 Color Film Chain, a TK-21 Monochrome Film Chain, a TP-15 Multiplexer, a TP-6 Film Projector and a TP-35 Film Projector. A TP-3 35-mm Slide Projector which operates through a periscope attachment on the multiplexer is also included. Control equipment for the film system will be located in new console housings. Only two cabinet racks will be necessary to house auxiliary equipment for both the TK-26 and TK-21 Camera Chains.

Complete Live Color Camera Equipment

The TK-41 live color camera will be set up in a small studio complete with lighting and props. It will be a continuous source of live color pictures. Only two cabinet racks will be required to house all equipment, including control desk, necessary to operate the RCA TK-41 Live Color Camera.

Reduction of rack space is made possible by using the new WP-15 power supply. This provides 1,500 ma output and requires only 10½ inches of rack space. Two of these

power the live color camera equipment, as compared to three WP-33Bs and two 580-Ds formerly required, adding up to a 70 percent reduction in rack space.

Low-Cost Compact 6-KW TV Transmitter

The latest developments in television transmitter design have been incorporated in RCA's new 6-kw low band TV transmitter, TT-6AL, which will be shown for the first time. An ideal transmitter for stations requiring 5 to 50 kw erp, it has power reserve to drive a 25-kw amplifier for maximum erp.

The TT-6AL requires the least amount of floor space of any transmitter in its power class and at the same time offers many up-to-the-minute design advantages. Linearity correction circuits built into the modulator provide for color operation without modifications. Built-in control relays, motors for operating power output controls, and shunts for external metering circuits make the transmitter ready for remote control. Low cost operation is assured through the use of 5762 air-cooled tubes with a proven record for long life and reliability. Group indicating lights plus excellent accessibility greatly simplify maintenance.

Two New AM Transmitters

Highlighted in a complete display of radio station equipment will be the new RCA 50 kw AM "Ampliphase" transmitter. A new concept in AM transmitting equipment, the RCA "Ampliphase" represents the most significant step forward in AM transmitters since RCA introduced high level modulation. "Ampliphase" cuts transmitter floor space requirements and operating cost by substantial margins; does away with half of present power tubes along with bulky components such as modulation transformers, reactors and accessories. Contained in only four cubicles (half the space required for other 50-kw equipments), it requires no underfloor trenches, costly water cooling systems or external blowers.

Of special interest to the economy minded will be the BTA-1MX 1-kw AM transmitter. You'll see this low cost transmitter with features previously available only in higher-priced equipments. Included are bi-level modulation for the ultimate in low distortion audio, space-saving mechanical design and adaptability for remote control. The low initial cost of this transmitter is coupled with low tube costs (less than half the number of tubes used by other 1 kws) for extra savings.

Family of New Audio Consolettes

Shown for the first time are three new consolettes, BC-5A, BC-3B and BC-6A, that represent the widest choice of audio

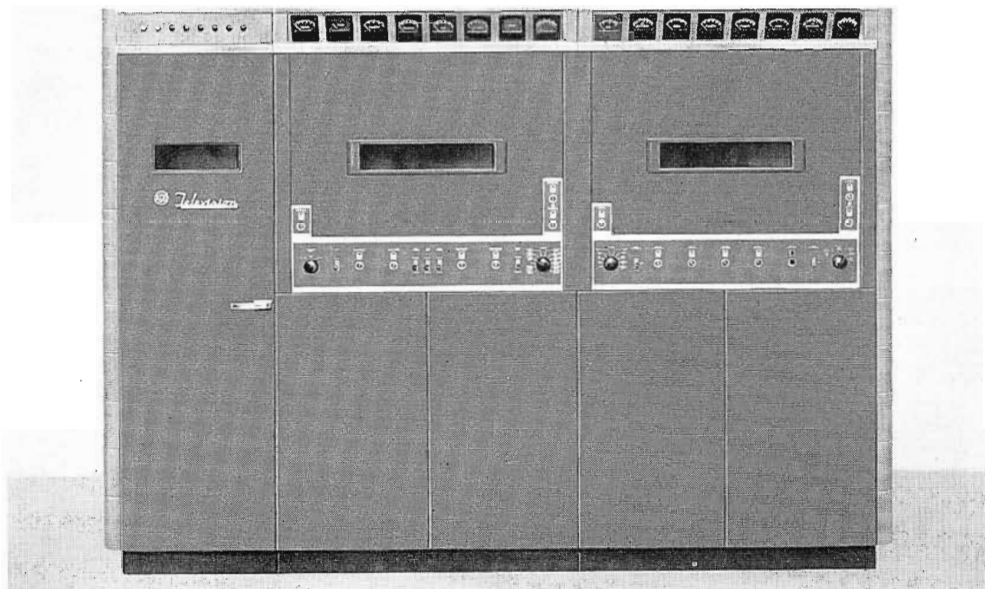

FIG. 3. Compact new 6-kw TV transmitter for medium power markets offers both cost and space saving benefits.

consolettes ever offered. All contain etched wiring amplifiers in modular construction to provide the utmost in circuit uniformity. Each has its own built-in power supply, speaker relays and monitoring amplifiers to eliminate the need for external wiring. Styled as a family, they may be used together to satisfy custom requirements.

The BC-5A has nine inputs on four mixer positions with facilities for four microphones, two turntables, two remote lines and one network or tape. It has its own built-in power supply and can be easily expanded for dual-channel use by pairing. Block building design enables this consolette to be added to existing BC-2B consolettes for expansion of facilities.

The BC-3B has thirteen inputs on eight mixer positions with facilities for six microphones, two turntables, two remote lines, one network and two utility inputs which can be used for additional turntables, tape or as required. It has its own built-in power

supply and is easily expanded for dual-channel use by pairing with the BC-5A. Included is a convenient script rack.

The BC-6A has twenty-two inputs on nine mixer positions with facilities for ten microphones, two turntables, two tape, two film, five remote lines and one network. It features either dual or single-channel operation by means of "split mixer" faders. In dual-channel operation, a master fader controls both channels simultaneously . . . ideal for binaural broadcasting. The BC-6A includes two built-in power supplies (one for each channel). Also included are two monitoring channels one for program monitoring and talkback, the other for cuing and feeding background to studios.

This display of equipments for radio and TV broadcasting will show all the latest advances achieved by RCA engineers. Plan to visit the display. RCA representatives will be on hand to demonstrate the equipment and assist in any way possible.

FIG. 4. First of its kind, RCA "Ampliphase" 50-kw AM transmitter cuts space requirements and operating cost.

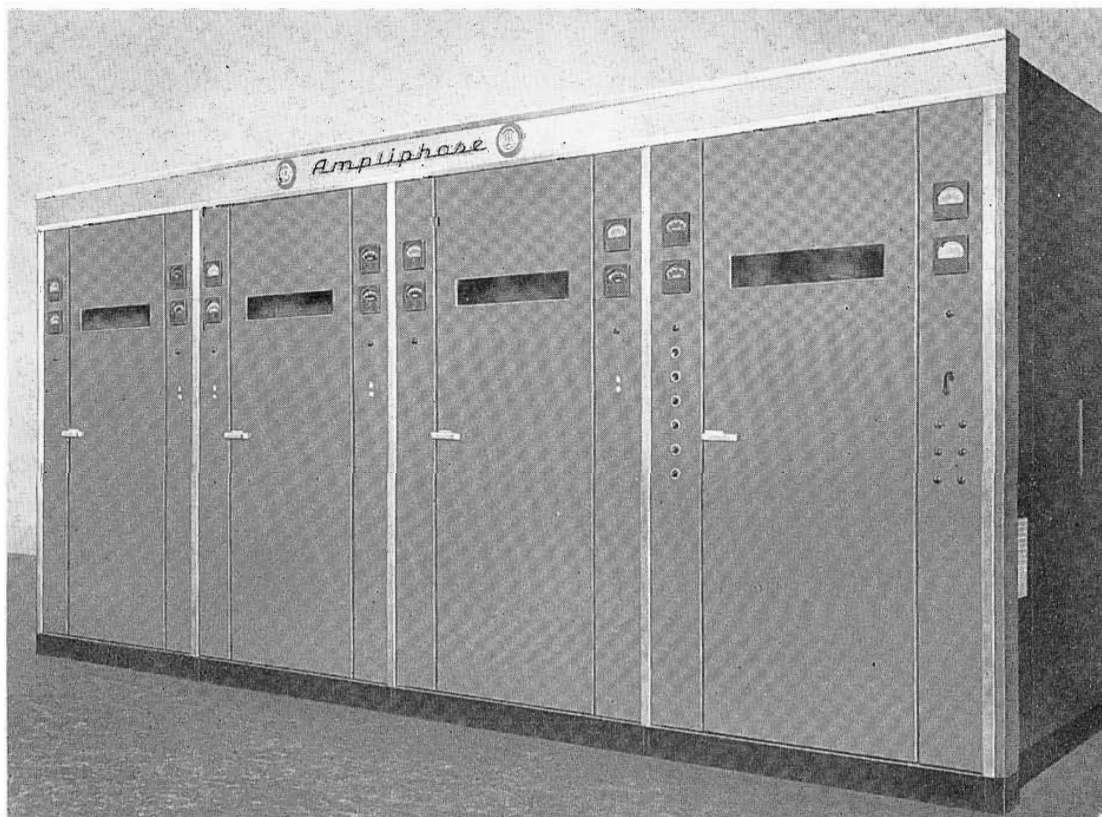

WDMJ TO INSTALL 170-MILE RCA MICROWAVE SYSTEM

*Multiple Hookup Will Enable WDMJ to Make
"Off Air" Pickup of Network Programs*

Installation of a three-hop broadcast microwave system will shortly enable station WDMJ, new VHF TV outlet in Marquette, Michigan, to pick up for retransmission in its own broadcasting area, network programs carried by station WBAY—170 miles away in Green Bay, Wisconsin. The new Marquette station, channel 6, is owned by the Lake Superior Broadcasting Company—Frank Russell, President.

WDMJ will install a pickup station within WBAY's broadcast range to permit

direct "off-air" reception of WBAY network programs. The signals then will be relayed through two microwave repeater stations to WDMJ's broadcast transmitter.

The installation will employ RCA TVM-1A high-power broadcast microwave equipment which is capable of up to 10,000 watts of effective radiated power. The broadcast microwave transmitter produces 1-watt power output on any selected frequency between 5,850 mc and 7,125 mc. This increased power means greater operation reliability with an increased fading margin.

The WDMJ microwave system is comprised of three relay transmitters and three receivers. This combination results in a highly directional wideband relay link especially suited to the transmission or reception of television video signals, color or monochrome.

Simultaneous transmission of sound along with picture information is accomplished by the high quality audio channel.

High stability, easy initial setup and a minimum of operator attention are characteristic of the relay system. Special electrical shielding effectively reduces interference from the local transmitting equipment.

An extremely desirable feature of the system from the servicing standpoint is the provision for monitoring the video signal transmitted from each relay station at the station itself. This is an exclusive system of "off-air" monitoring.

This RCA TVM-1A microwave relay is widely employed by many television broadcasters for studio-transmitter links, for remote pick-up and for bringing network connections to unreachd areas.

COLOR TV "STUDIO-ON-WHEELS" PURCHASED BY SMITH, KLINE & FRENCH FOR MEDICAL DEMONSTRATIONS

*First Mobile Compatible Color TV Unit for Medical Use
Will Be Utilized by Philadelphia Pharmaceutical
Firm for Presentations at Surgical Meetings*

A compatible color television "studio-on-wheels" for medical use—the first of its kind—has been purchased from RCA by Smith, Kline & French, Philadelphia, Pa., pharmaceutical firm, for closed-circuit presentations of surgical and clinical demonstrations.

The new RCA-built mobile unit, which is similar in appearance to that shown on Pg. 56, incorporates two "live" color TV cameras and all the control room equipment

necessary for SK&F's Color Television Unit to originate medical colorcasts from virtually any hospital in the country. Included in the equipment, which involves approximately \$200,000, but not part of the mobile unit, is a 3-Vidicon live color camera chain recently developed by RCA for specific use in colorcasting surgical and clinical demonstrations. Plans also call for SK&F to use an RCA large-screen color TV projection system.

This compatible color TV "studio-on-wheels" also will enable SK&F, for the first time, to originate and transmit medical colorcasts to TV stations for local or network broadcast. The "studio" includes complete video and audio equipment for program origination and facilities for three technicians and a program director. It features a custom-built body and chassis and such facilities as heating and air-conditioning systems, power steering and air brakes.

In operation, the mobile "studio" will be parked outside a hospital and connected by cable to the three color TV cameras operating within the hospital, televising surgical and clinical procedures. Signals picked up within the hospital will be received by the mobile unit and transmitted by closed-circuit to the remotely located projector and screen.

Smith, Kline & French laboratories is a pioneer in closed-circuit color TV and sponsors an average of 15 programs a year before surgical and medical meetings. These colorcasts, presented as a service to the medical profession, highlight latest advances in surgical and clinical techniques and attract a total of 50,000 to 60,000 visitations by surgeons and physicians.

The availability of standard studio broadcast equipment for closed-circuit colorcasts will enable SK&F to introduce higher defi-

nition and greater color accuracy of picture. This will add appreciably to the value of these SK&F medical demonstrations for medical audiences.

Equally important, the incorporation of these standard broadcast facilities in a custom-built "studio-on-wheels" will introduce greater overall economy, simplicity and speed in the movement, setup and operation of medical "road shows." The mobile unit will enable the SK&F crew to carry complete control room and studio equipment as they move from city to city—a vital consideration in a program schedule which involves an average travel of 40,000 miles annually.

The first medical color television broadcast was sponsored by SK&F in June, 1949,

before the convention of the American Medical Association in Atlantic City, N. J. Sequential equipment was used. From that date to December, 1955, SK&F produced programs before 79 medical and surgical meetings, with a total of 1,135 clinical presentations and 706 surgical operations. The programs, involving nearly 900 hours, attracted approximately 400,000 visitations by surgeons and doctors.

In describing SK&F's plans for using the new unit, Mr. G. F. Roll, SK&F's Director of Public Relations, said: "We have concentrated on color presentations because the realism which color visualization provides is the essence of the value of the closed-circuit TV medium. In surgery, for example, form and contrast alone are not sufficient to provide a true picture of human tissue, areas

of infection, location of vital arteries and veins, or the extent of circulation. The addition of color in such televised presentations, particularly those of broadcast quality, provides the required realism and authenticity. Color TV also gives a sense of third dimension not obtained in black-and-white pictures, which is invaluable in revealing the extent and depth of lesions and incisions."

The RCA "studio-on-wheels" measures 28 ft long by 12 ft high, and is divided internally into operating and storage areas. All control equipment is housed in the operating area. Essential equipment carried by the mobile studio will include two RCA studio color camera chains and associated audio, video, switching, synchronizing, and color test equipment.

NEW PORTLAND VHF TV STATION WILL BE FIRST TO INSTALL RCA 100-KW TRANSMITTER

Transaction Involves Approximately One Million Dollars and Represents Largest Installation of RCA Equipment for Independently Owned Color TV Station; New Outlet Scheduled for Completion Before July, 1956

Purchase of a complete RCA 100-kw VHF television installation by a new color TV station in Portland, Oregon, was announced recently as the first installation of its kind in the country.

The announcement was made jointly by Gordon Orput, President, and J. L. Middlebrooks, General Manager of North Pacific TV, Inc., which holds the construction permit for the channel 8 station, and by A. R. Hopkins, Manager, Broadcast and TV Equipment Department, Radio Corporation of America.

The new channel 8 Portland station, which will be completely equipped for origination of color television programs, hopes to complete installation before July, 1956. Subject to approval by the FCC, the station will utilize a new RCA 100-kw

transmitter and a unique RCA-developed 100-kw superturnstile antenna to achieve 316,000 watts of effective radiated power—the maximum established for high-band VHF television stations by the FCC. The most powerful VHF television stations on the air today utilize 50-kw transmitters.

A unique feature of the Portland installation will be the 100-kw antenna and a remote switching network which will enable the station to achieve maximum power with only a portion of its transmitter equipment should the need arise. The switching system will allow the station to segregate individual transmitting components for either emergency operation or routine maintenance.

In normal operation, the station will combine the 100-kw transmitter with a gain

of 3.6 in the antenna to achieve 316,000 watts of effective radiated power. When necessary, the station can also achieve maximum power by switching to combine a 50-kw portion of the transmitter with a gain of 7.2 in the antenna.

In addition to representing an advantageous standby feature, the switching arrangement is expected to produce informative comparisons on station coverage provided by both high-power, low-gain and low-power, high-gain types of operation.

The unique RCA 100-kw antenna is an eight-section type, split into two units embracing four sections each. The antenna is so designed that, during normal operation, visual energy will be radiated by the top four sections, audio energy by the bottom four sections. For emergency conditions, visual and audio signals from one 50-kw transmitter can be diplexed into the antenna's full eight sections.

The superturnstile antenna is approximately 46 feet tall, and will be mounted atop a 600 foot antenna tower to raise it 1,811 feet above mean sea level.

The new 100-kw transmitter will enable the Portland station to achieve saturation coverage from center to fringe-areas of its broadcast range. The high-power transmitter is expected to be particularly effective in providing maximum broadcast service throughout the rugged terrain of the Portland area.

Other essential RCA equipment included in the proposed installation are a 3-V color film-camera system; six camera chains for studio and remote location use; and two chains of broadcast microwave equipment.

FIG. 1. Merle Severn, KOMO-TV's Chief Cameraman shoots news film in color, develops it, and has it ready for airing in 90 minutes. Fast-processing technique makes possible local news coverage in color the day it happens, and affords brilliant color film of high broadcast quality using less lighting than was heretofore considered possible.



KOMO-TV ANNOUNCES PLAN FOR FAST-PROCESSING OF COLOR FILM

Seattle Station Airs Local News Film In Color Using Technique Which Readies Color Film In 90 Minutes

KOMO-TV, Seattle, has announced the introduction of fast-processing techniques which will enable the station to present spot news film in full color. Until recently the use of color film for local spot news stories was believed impractical because of the complexities of color processing. However, on February 20th, KOMO-TV showed that it could be done by presenting on the regular DEADLINE news program all the local film news shot that day in color! Ac-

cording to the station, press representatives who were invited to see the program were unanimous in their praise of the true color and the implications for future use of color news film.

KOMO-TV General Manager Bill Warren, who has sparked the use of local color wherever and whenever possible, gave Merle Severn, KOMO-TV's chief Newsreel Cameraman, full credit for working out the

details of the fast-processing technique, which, when used with new high speed color film, proved very successful.

In commenting on the use of color film for local newscasts, Mr. Warren said: "We feel this new development means that television can now do substantially everything in color that up to now, it has been able to do only in black and white. Cost, time delay in processing and more complex expo-

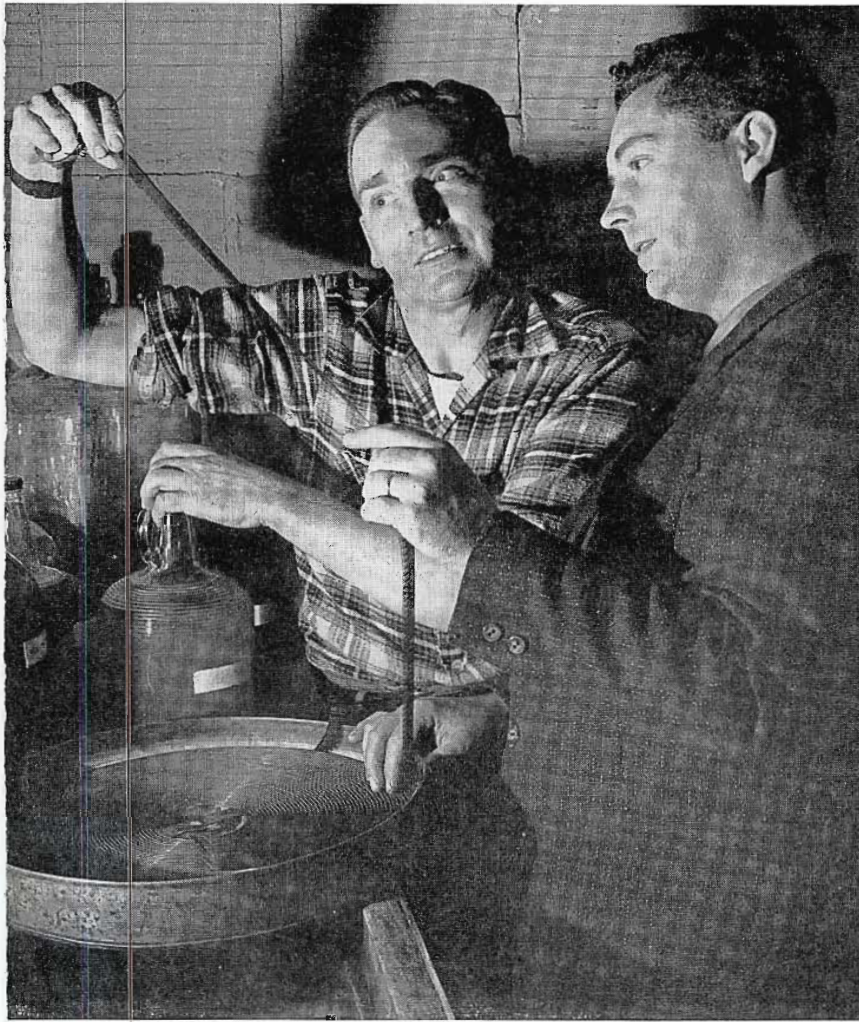

FIG. 2. Color film for KOMO-TV's news show "Deadline!" is processed by Merle Severn (r.) and Ed Waton of Forde Motion Picture Laboratories, the station's film lab in Seattle. Cost, time delay in processing and more complex exposure requirements of color film, which have been major handicaps in consideration of color film, have been largely overcome.



FIG. 3. Merle Severn prepares to preview color film he shot for Channel 4's news program "Deadline!" and developed in 90 minutes. Fast-processing technique makes possible local news coverage in color the day it happens. Development means television can now do substantially everything in color that up to now has been possible only in black and white.

sure requirements of color film which have been the major handicaps in consideration of color for news film, special events, etc., have been largely overcome. The method and film which Severn has utilized will eliminate these problems. They will bring processing time down to one hour and thirty minutes, or just 90 minutes to develop, dry and ready to go on the air: the cost increase will be relatively modest . . . approximately $\frac{1}{3}$ more than black and white; and exposures can be made almost as simply as with black and white. Processing equipment is simple, and inexpensive and should be within the reach of every station or its local laboratory. Stations equipped with color film chains should be able to augment their color film programs with local color news film, special events, and current community happenings, while advertisers at the local level should be able to make excellent quality film commercials in color easily and at low cost."

Mr. Warren said that Severn and KOMO-TV have turned over the investigational reports and findings on the new fast-processing techniques to Forde Motion Picture Laboratories in Seattle, where this organization is developing a modern production processing unit locally for commercial availability of the processes.

Mr. Warren also indicated that KOMO-TV has immediate color plans for the future. Several local programs will be done regularly in live color, and color news film will become a frequent occurrence as soon as the laboratory can turn it out using Severn's plan.

Description of Fast-Processing Techniques

The fast-processing technique used by KOMO-TV has been described and discussed by Merle Severn in a press release issued by the station. The material which follows is extracted directly from this re-

lease and is quoted in Mr. Severn's own words.

"The immediacy requirements of television require that color film be processed by the station itself or by a private lab set up to handle the station's business.

"The color film must be selected that is most easily handled. It cannot be a bipack nor a tripack for these require more than one film base. Therefore, it must be a monopack (integral tripack) because it consists of one base the three emulsions superimposed upon it.

"So far as I have been able to determine, Ansco has produced the first answer. The original Ansco color was replaced last year by the new Anscochrome, an integral tripack, unique because its color-forming materials remain in the emulsion during first processing and do not have to be added later and separately. This film is made up similar to other such types of films with the

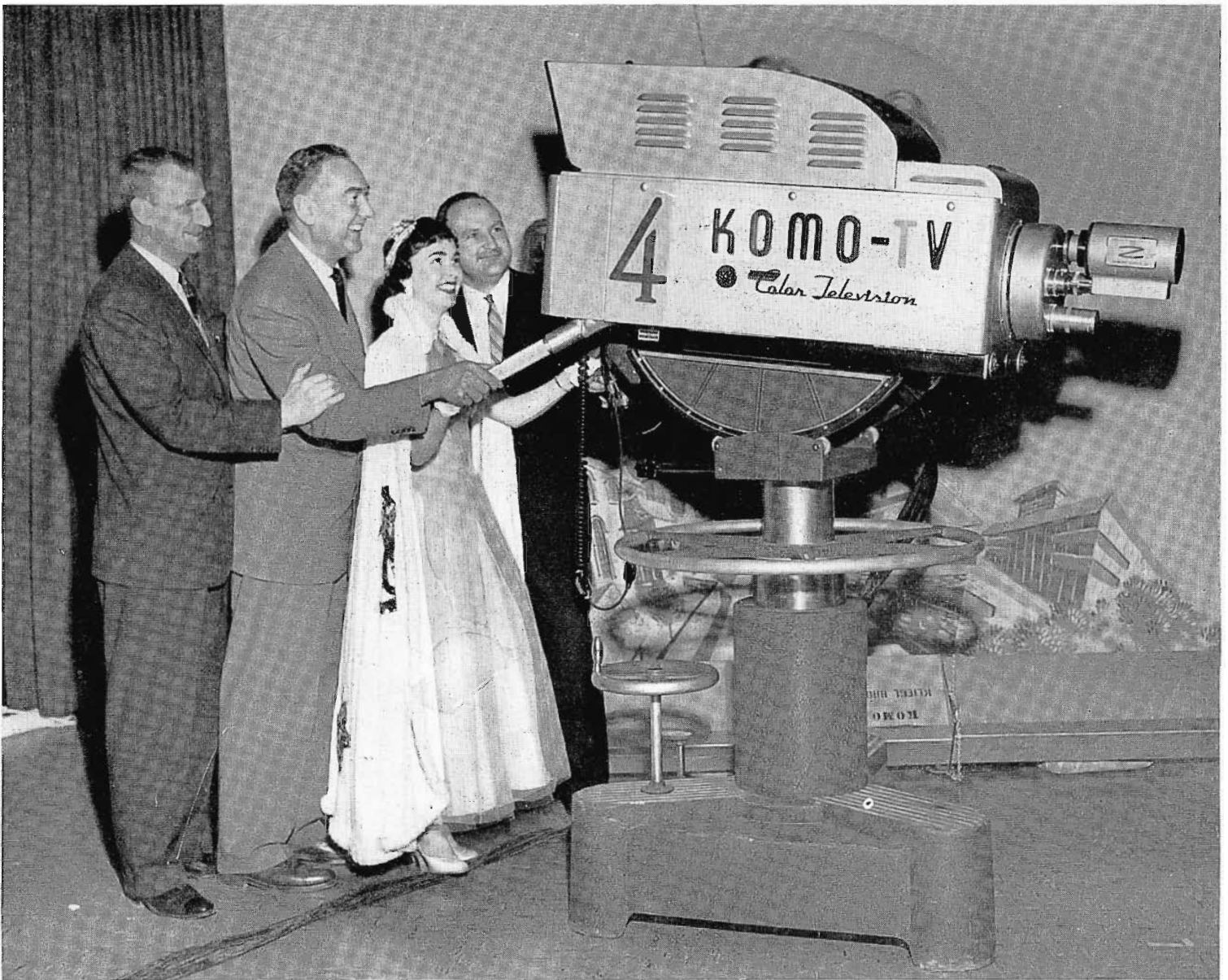

FIG. 4. KOMO-TV is now on the air with network, film and live color. Under the direction of Cliff Miller, KOMO-TV Chief Engineer, the station's transmitter was modified for color and the first network color program aired on August 11, 1954. In May 1955 an RCA 3-V Color Film Chain was installed, and in January of this year an RCA TK-41 Live Color Camera was added to the station facilities. Shown above, at KOMO-TV's Live Color Camera Inaugural are, (l. to r.) Gene Gollihur, vice-president of Fidelity Electric Co.; Jules Renhard, RCA Broadcast Representative; Miss Carol Price, who has been chosen KOMO-TV's "Miss Colorvision of 1956"; and Ort Wagner, RCA Television Representative, Fidelity Electric, RCA Distributor, has been cooperating with KOMO-TV in promoting color television in Seattle.

blue sensitive layer on top, the green in the middle and the red layer at the bottom. Its value lies in the fact that all three of these color sensitive layers respond alike to changes in developing time. With former color films the least change in time or temperatures would immediately make one color predominate over other colors. Anscochrome can practically be wrestled about in the same manner as black and white film is now handled and still will result in acceptable color. Another amazing value of this film's 3 color-layers equal response is its ability to be used at faster emulsion ratings by just equally increasing the time of the first and color developer. Ansco recommends this film at ASA 32 but it is equally

possible to expose the film at ASA 125 and still retain good color. A third factor that makes Anscochrome acceptable for newsreel work is its soft color gradation and wide exposure latitude.

"The major problem in presenting news in color is processing, but because of the latitude and response of Anscochrome, the average station can now process its own film or, if it operates in conjunction with a commercial lab, this lab can set up the necessary facilities to handle color film.

"There are three major ways of handling the processing: machine, reel and trough, or rack and tank. Machine processing is expensive. It requires an automatic processing

machine which will cost over ten thousand dollars. While it is the most efficient, it requires large volumes of chemicals and is not practical for small amounts of footage.

"The reel and trough method consists of a drum rotating through a trough of solution. This type of operation requires small amounts of solution, but there are strong tendencies for aerial oxidation to deplete the life of the chemicals and because the reel carries the film out of the developer for periods of time it may well cause strain.

"Finally, we have the famous old rack and tank method. Here the film is wound onto a flat rack and submerged completely into the solution. This system requires more

solution than the reel and trough but for the average lab it will produce the best color more economically.

"Our lab has produced a version of the rack and tank. It consists of a master water jacket thermostatically controlled at 68 degrees into which are set six plastic tanks designed to hold a rack onto which can be wound 200 feet of color film. As each chemical solution is held exactly at 68 degrees you have a standard by which your film can be exposed. An off-center bar is being devised to produce automatic agitation.

"This machine is capable of producing consistently good results without great outlay of money and has met the approval of J. L. Forrest of Ansco's Motion Picture Development Laboratories in Binghamton, New York. Another advantage to this particular system is that by using racks which move along in these six separate plastic tanks, additional racks carrying equal amounts of film can progress along in systematic order. Therefore, other film need not be delayed until the first film completes

the entire cycle. With a drum-type drying rack passing by heat lamps the color film should be ready to be televised within an hour and a half after it enters the processor.

"It still is possible to produce good color film in coffee cans, Morse tanks and by way of the Stineman system. All of KOMO-TV's original experiments were carried on in a Morse tank and excellent results were obtained, but these systems require clean, systematic procedure. The accompanying chart gives times for all procedures but variations will be encountered due to individual technique.

"Listed below are at least five different techniques with which KOMO-TV has experimented in one variation or another. All will produce acceptable results and offer unlimited possibilities for handling color newsreel film. Problems will be encountered but they exist largely because of some small error along the way. To the man who has never processed black and white reversal it may indeed seem a complicated system . . . to the man who knows reversal, it is not a

great deal different. The amateur photographer down the street is able to take a yard of film out of his Rollei and process it into good color. The only difference in movie film is that 100 feet of film is a little harder to handle. Anscochrome offers a margin of error . . . it's that margin that makes it the first candidate for color news."

SUGGESTED TIMES FOR TESTING ANSCOCHROME PROCESSING

NOTE: Indicated times are for testing motion picture film exposed at ASA 32 and temperatures of chemicals at 68 degrees. For film exposed at ASA 64 increase first developer 30 percent and color developer 15 percent. For film exposed at ASA 128 increase first developer 100 percent and color developer 35 percent. Variations will be encountered due to individual techniques, 100-ft. rolls except as indicated.

Process	Machine	Rack & Tank	Morse Tank	50 feet in Morse	Notes
1st Dev.	15	18	36	25	
Shortstop	3	4	7	5	
Hardner	3	4	7	5	
Wash	3	4	7	5	
Re-Exposure	During Wash	During Wash	See below	See below	
Color Dev.	15	18	36	25	Hold at 68°
Shortstop	3	4	7	5	
Hardner	3	4	7	5	
Wash	3	4	7	5	
Bleach	6	8	14	10	} If not fully bleach backing sticks Wash well
Wash	5	6	7	7	
Fixer	6	8	14	10	
Final Wash	10	10	14	10	
Drying	Dry Box	Reel	Reel	Reel	

AD DATA

Reel and Trough—Equals machine processing time.

Stineman System—Equals Rack and Tank processing time.

Morse Tank—Advise 50-ft. length to shorten processing time and prevent additional abrasion to film. Film should be wound end for end at rate of twice per minute with steady even wind—be careful not to jerk at end of roll.

Re-Exposure—Place No. 2 photofoods in such a position that both sides of the film will get approximately a MINUTE of light—little danger of overexposing. For Morse film should be taken from tank and reels turned on pegs about 4 times through a cross-fire of light. Stineman reels do not require removal of film—just shine light down on open side of reel and it will penetrate.

Drying—Advise dipping film into wetting agent solution or 0.1% solution of liquid detergent then wipe film evenly with chamois. Place on spinning reel under heat lamps—drying should take less than 10 minutes. Film contracts greatly so leave slack in loops.

ANSCOCHROME PROCESSING

NOTE: Packaged kits for processing Anscochrome can be purchased in quart, gallon or 3½ gallon sizes. It is suggested that these prepared kits be used in testing. Replenishers available.

FIRST DEVELOPER—502A-3

Water—100 fl. oz.
 Calgon—58 grains
 Metol—175 grains
 Sodium sulfite (dry)—6½ oz.
 Hydroquinone—350 grains
 Sodium carbonate (mono)—5¾ oz.
 Sodium Thiocyanate—117 grains
 Potassium bromide—117 grains
 0.1% potassium iodide solution—1 oz.
 Water to make—1 gal.

SHORTSTOP—859B

Water—100 fl. oz.
 Acetic acid (glacial)—½ fl. oz.
 Sodium acetate—4 oz.
 Water to make—1 gal.

HARDNER—901

Water—100 fl. oz.
 Potassium chrome alum—4 oz.
 Water to make—1 gal.

COLOR DEVELOPER—607

Water—100 fl. oz.
 Calgon—58 grains
 Sodium sulfite—292 grains
 S 5—292 grains
 Sodium carbonate—16 oz.
 DA 3—162 grains
 Potassium bromide—58 grains
 Water to make—1 gal.

BLEACH 716-1

Water—100 fl. oz.
 Potassium ferricyanide—13½ oz.
 Potassium ferrocyanide—3H₂O—2¼ ozs.
 Sodium bromide—2 oz.
 Disodium phosphate—1½ oz.
 Citric acid—1 oz.
 Formalin (37%-40%)—2 fl. oz.
 Water to make—1 gal.

FIXER 800-B

Water—100 fl. oz.
 Sodium thiosulfate—26¾ oz.
 Sodium sulfite—292 grains
 Boric acid—233 grains
 Borax—175 grains
 Water to make—1 gal.

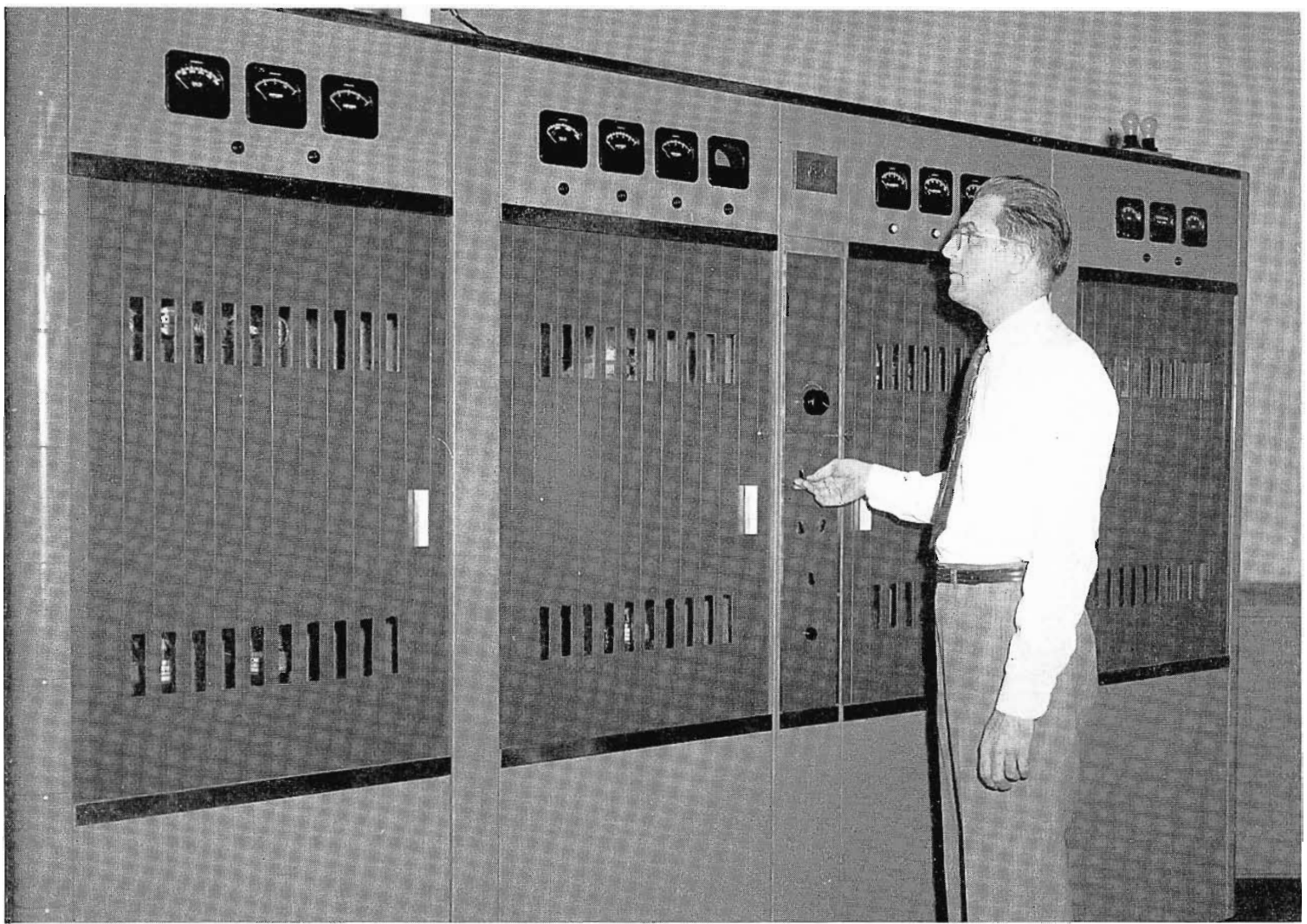

WFBR William Doster is shown at WFBR's new BTA-5H transmitter—ready to throw the "plate-on" switch.

RCA 5-KW AM TRANSMITTERS SET STANDARDS FOR HIGH FIDELITY PERFORMANCE

On this and following pages are a few typical RCA 5-kw transmitter installations. More than thirty broadcasters have procured Type BTA-5H 5-kw AM transmitters within the last year. They wanted the very best in a 5-kw AM transmitter—this they have in the new RCA equipment. The transmitters are proving their wide range of usefulness by serving small, medium and large markets. Ease of operation and all-around economy are standout benefits.

An outstanding feature of the BTA-5H transmitter is the use of "Bi-level" modulation. This is accomplished by adding a controlled amount of audio to the r-f driver to increase efficiency and reduce distortion and power consumption. By modulating the plate of the r-f driver, the linearity of the power amplifier has been improved.

Operating costs on these transmitters are way down owing to low tube costs and the use of smaller power tubes, fewer stages and fewer tubes. Power amplifier and modulator stages both utilize 5762 tubes, thus reducing the number of tube types and making it possible to interchange tubes to increase useful life.

Performance has been enhanced by such techniques as thyatron-control of the power supply, bi-level modulation and split-cycle recycling of the overload and arc-back protection circuits. Recycling works so fast that audiences cannot detect "off-air" breaks. This high-fidelity performance has been well received. Broadcasters have told us that they can tell which station in an area is using an RCA 5-kw transmitter merely by listening to the signal.

These transmitters require less operating floor space than other 5-kw's; their compact design is evident from the photographs of actual installations. Four cubicles house the entire transmitter and consist of (from left to right): the modulator; the power amplifier; the exciter; and the power rectifier. Phasing and branching equipment are housed in matching left-wing cabinets where directional arrays are employed. Increasing to 10-kw may be done easily and inexpensively without increasing cubicle or floor space.

The stations illustrated are some of the many users of the BTA-5. These 5-kw transmitter installations are becoming the standard for the industry. They combine the finest high fidelity performance with low-cost operation.

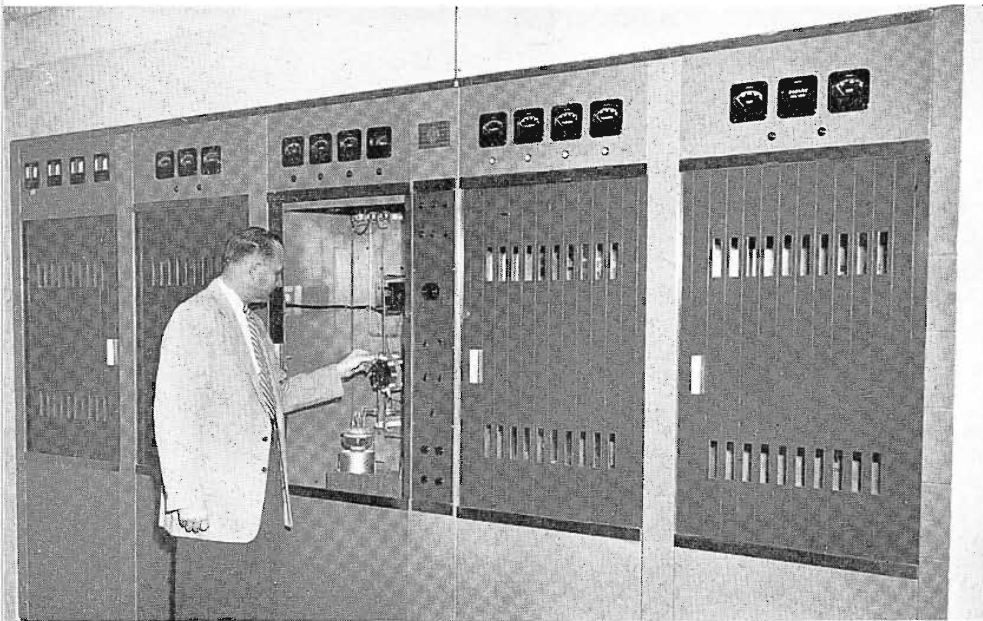

◀
WXLW

Norbert J. Goetzing, Chief Engineer, checking connections on the neutralizing transformer in the power amplifier cabinet.

KYA

▶ Montague Baucroft, Maintenance Supervisor, checking final amplifier tube connections.

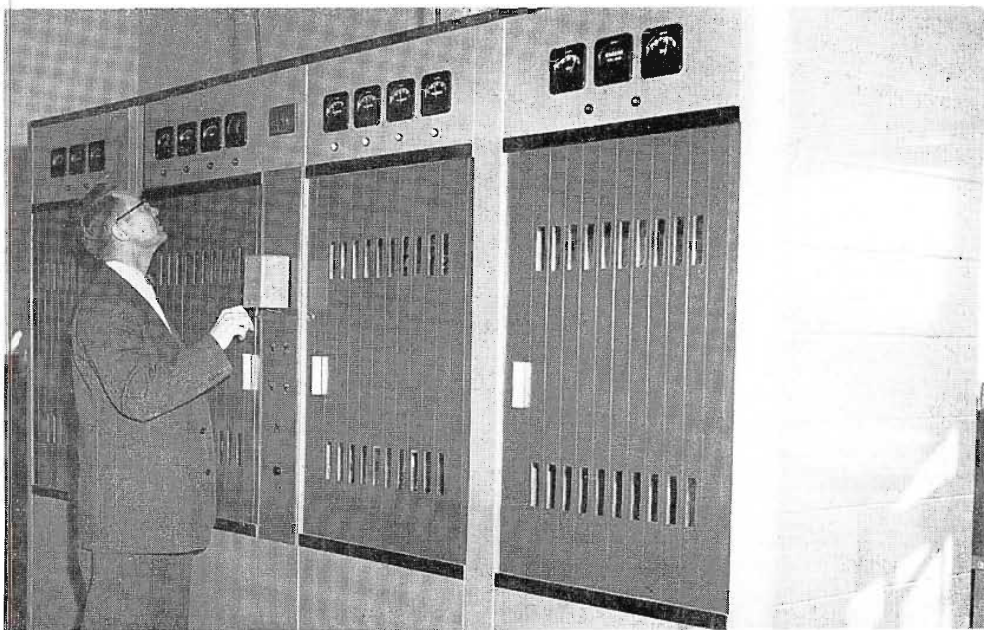
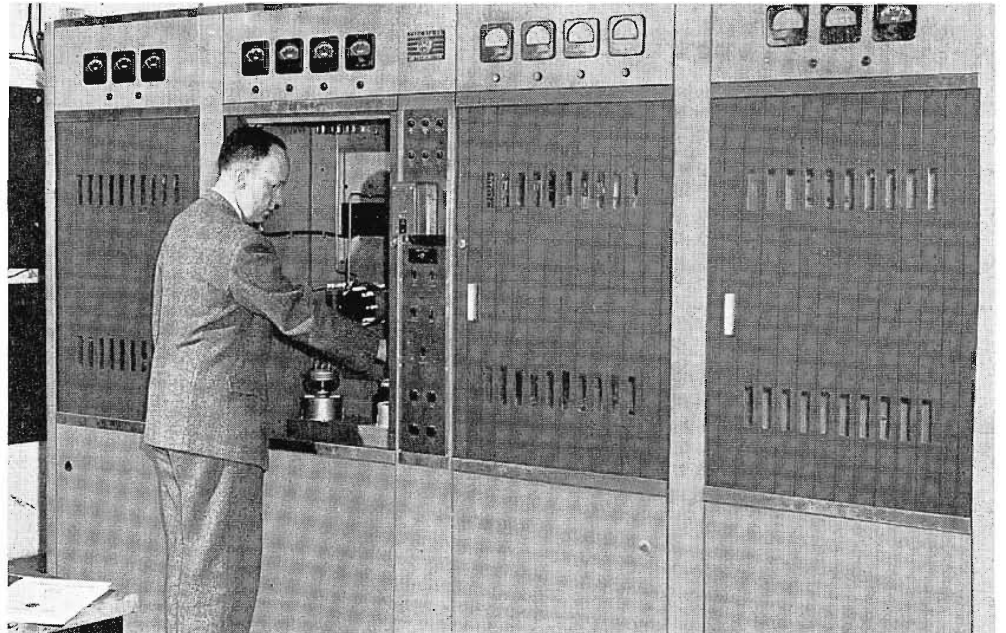

◀
WTAR

Richard Lindell, Chief Engineer, tuning the plate circuit of the power amplifier by adjusting the variable vacuum capacitor.

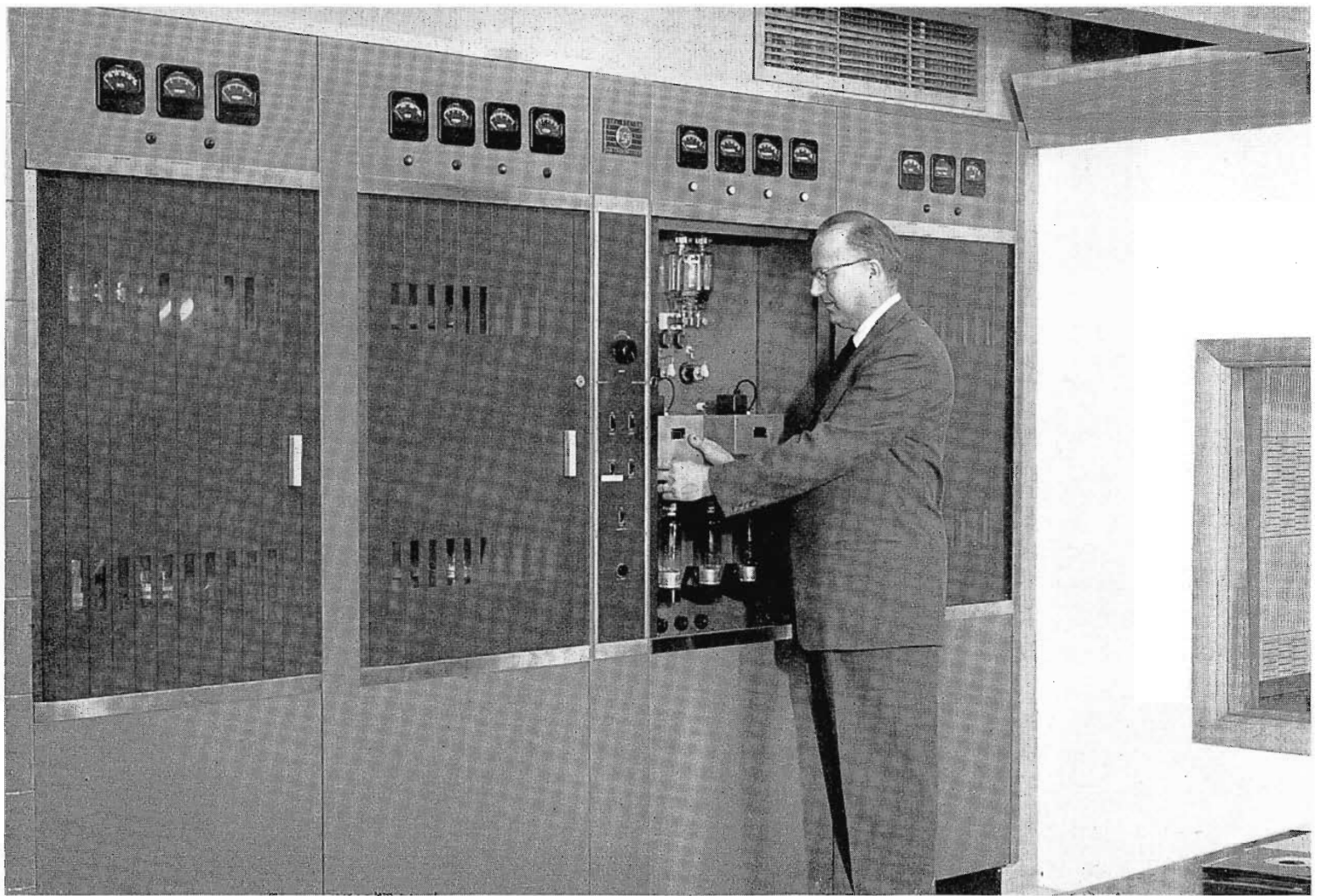

▲ **WEMP** Rolland E. Paske, Chief Engineer, at the exciter cabinet. Two crystal oscillator units are supplied—one as an auxiliary. The crystal oscillator feeds two RCA 807 tubes in parallel operating as a buffer amplifier.

WTMJ William H. Hebal, Chief Engineer of AM, adjusting the power-output control. A manually operated selsyn motor, used as a phase-shifter, provides front-panel control of the output plate voltage. ▼



WAVE

Wilbur E. Hudson, Chief Engineer, at the power-rectifier cabinet. The front compartment of the power-rectifier is accessible at all times and is not interlocked but fully protected to permit operation of control switches.

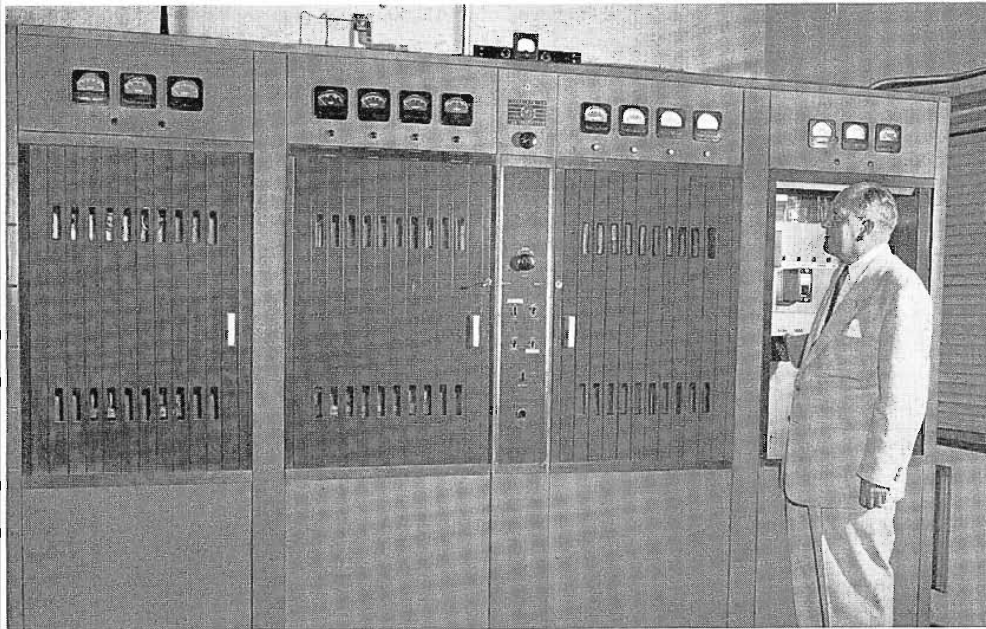
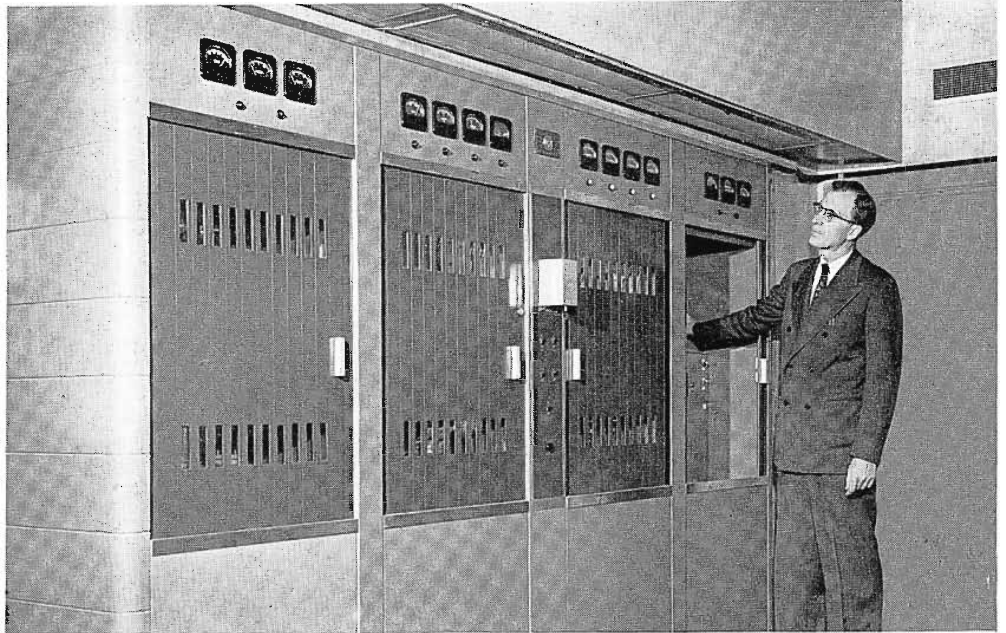

KFWB

Henry Myers, Chief Engineer, shown at the power-rectifier cabinet. Switch being thrown allows filaments to be turned on or off manually.

WCED

Burrell Morris, Chief Engineer, adjusting power-output control. There are only two tuning controls and one power-output control in the BTA-5H transmitter.

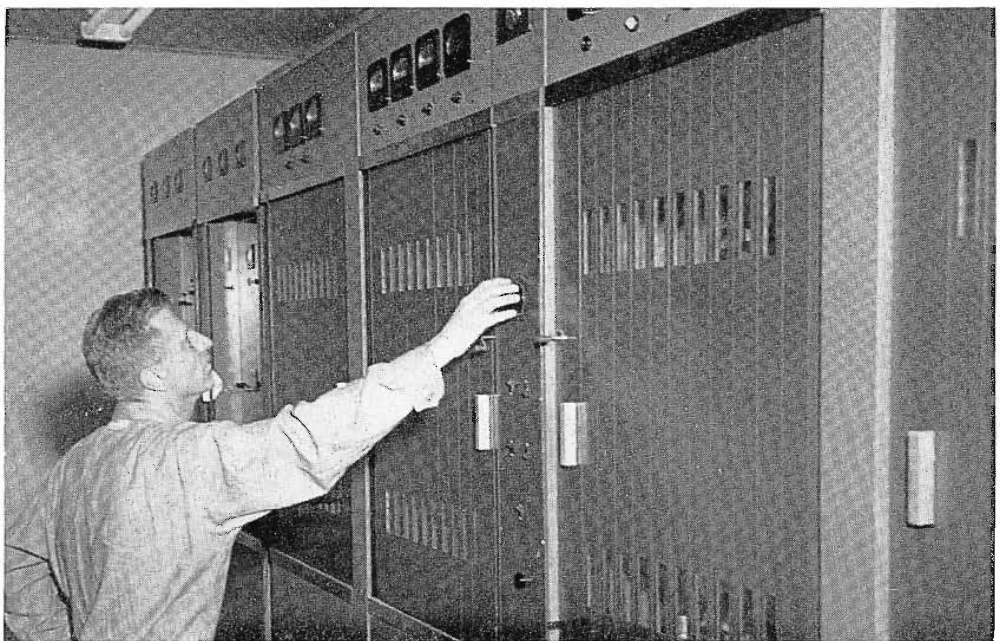



FIG. 1. Kukla, Fran & Ollie (Fri., 10:30-11:00 pm) is one of WNBQ's outstanding live color originations. Program, aired in color for past several months, has been acclaimed as a natural for the medium. In commercials (for RCA Whirlpool) Fran Allison points out and explains features of washers and dryers. Color greatly increases effectiveness of these commercials. In rehearsal picture, shown here, Jim Edwards, TV engineer, is operating RCA TK-41 Studio Color Camera.

WNBQ STARTS "ALL-COLOR" OPERATION

NBC's Chicago Station Making All Live Originations In Color

On April 15th, WNBQ became the world's first "all-color" television station. On that date the station "switched" from its old monochrome facilities to its all-new all-color facilities, and began making all local live originations in color. As many as possible of its film originations will also be in color. Monochrome equipment is being removed and will soon be dispensed with entirely.

Initially WNBQ will originate approximately five hours a day of local live color. Programs making up this five hours are shown in the box on the next page.

In addition to these programs WNBQ will carry all NBC network color programs and as many of its film programs as possible in color. This means that the station will have an average of 7 hours a day in color from now until fall at which time the total should increase considerably.

WNBQ's start in color was timed to coincide with the opening of the 1956 NARTB Convention in Chicago's Hilton Hotel so that the two thousand broadcasters attending the convention would have an opportunity to inspect the station's color facilities and observe first-hand the possibilities of all-color operation. Opening ceremonies, telecast on the NBC network as a segment of "Wide Wide World", were viewed by several hundred special guests and officials on receivers in the Merchandise Mart's M&M Club. On Monday, April 16th, a segment of the "Camel News Caravan" (6:45-7:00 pm CST) will originate from WNBQ and on Tuesday, the 17th, "Today" (7:00-9:00 am CST) will visit the new color studios.

Intensive Promotion

A quarter-million dollar promotion campaign will publicize the WNBQ color operation to the industry and the public.

WNBQ itself will use nearly \$100,000 worth of TV and radio spots, plus full page newspaper ads, car cards, 3-color sky writing and space in TV fan and industry magazines. The RCA Distributing Corporation will stage a simultaneous push for color receiver sales in the Chicago area. During the week of April 16-20 color programs will be fed by way of closed circuit to twenty some locations about the city—including department stores, hotels, banks and other locations where they will be seen by large numbers of people. This circuit will carry all of WNBQ's color programs plus locally originated color film programs whenever WNBQ is carrying network monochrome programs. This will provide round-the-clock color programs during the first week of color operation.

Tours for NARTB

In order to make it convenient for broadcasters attending the convention to see the

FIG. 2. "Elmer the Elephant and John Conrad", a regular WNBQ half-hour program (5:00-5:30 pm), will be telecast daily in color starting April 16. With its colorful sets and costumes it is a natural for color. Aired back-to-back with "Howdy-Doody" (in color from New York) it gives WNBQ a solid hour of "color for the kids" every evening. In rehearsal picture, shown here, Frank Nault, TV engineer, is operating camera.

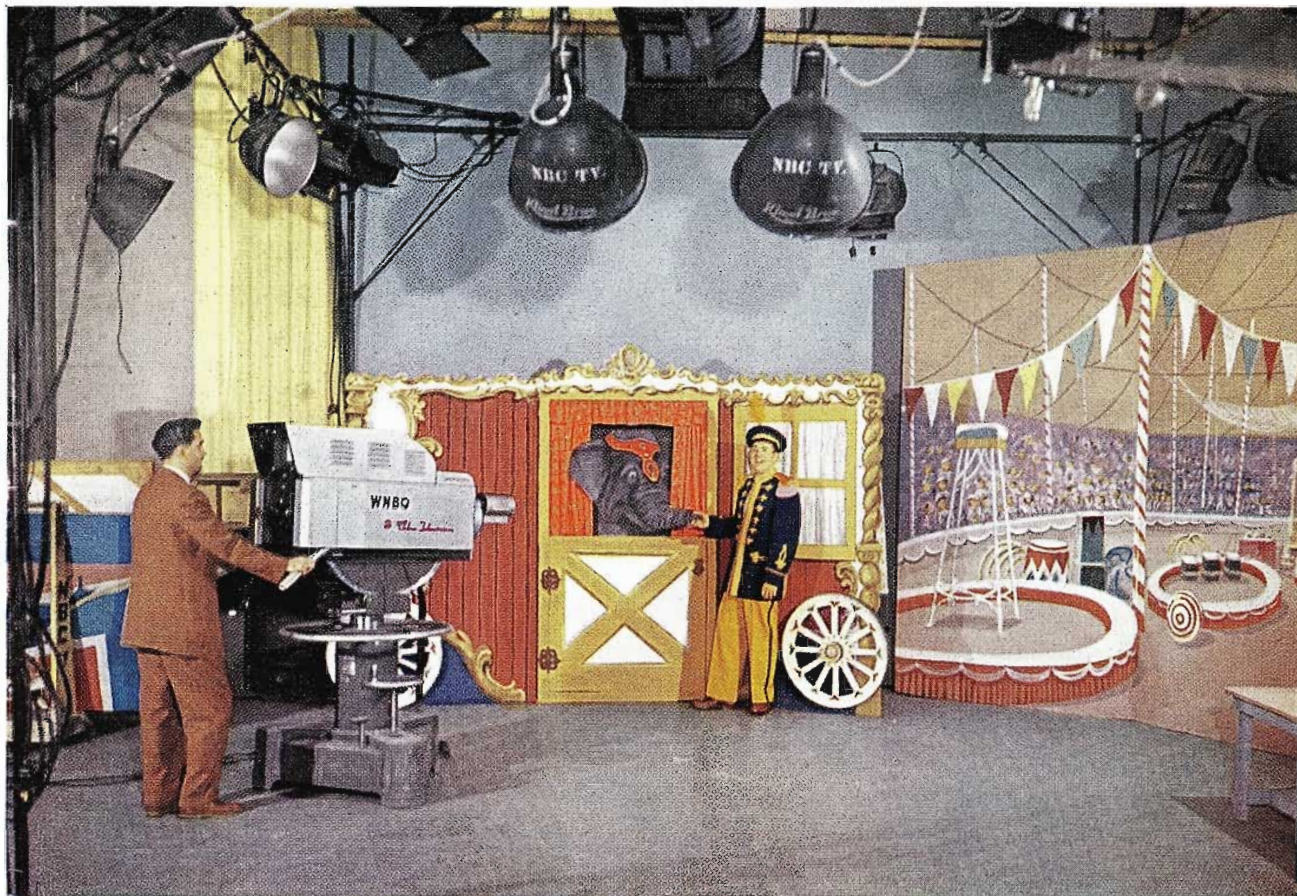

new WNBQ setup the station has arranged for busses to operate between the Hilton Hotel and the Merchandise Mart. Bus tickets are available at the NBC suite in the Hilton or at the RCA Exhibit on the lower floor of the Hilton. Guests taking the bus to the Mart will be met at the door and taken on an escorted tour of WNBQ's color facilities.

Equipment Features

Broadcasters taking the WNBQ tour will see the largest and most complete station color equipment installation made to date. Five RCA TK-41 Live Color Cameras and two RCA TK-26 3-V Color Film Cameras have been installed together with complete color switching and distribution facilities. These seven color cameras will enable WNBQ to do all its local originations in color with sufficient spare equipment for handling simultaneous rehearsals and previews. The 3-V Film Cameras, of course, can handle monochrome as well as color, thereby providing for dual operation until the time arrives when all film, as well as live, can be in color.

With the exception of a few minor units all of the color equipment in WNBQ's new setup was furnished by RCA. Except for the custom switching system all the equipment units are of standard types. In each

instance the very newest models have been used. For example, the color camera chains use the new RCA processing amplifier which has cut the required rack space in half from earlier models. A further saving in rack space has been effected by using the brand new RCA WP-15 Power Supply. This unit, which is rated at 1500 milliamperes, needs only 10½ inches of rack space and replaces 2½ old style units requiring a total rack space of 35 inches.

The video switching system at WNBQ was custom-built by RCA to NBC designs. The signal distribution paths in a network originating installation are rather complex and for that reason exacting specifications had to be placed on parameters which might have an affect on color transmission quality. Differential gain and phase, frequency response and envelope delay all had to be controlled to very narrow tolerances. The relay switching system built to meet these requirements utilizes the "pizza pie" switcher developed by NBC engineers. In this switcher the relays are arranged in a circular arc (the "pie"). This keeps the distributed capacitance of the switching circuits low so that the frequency response can be made flat out to very high frequencies.

Another feature of the WNBQ color switching system is that provision for lap

DAILY COLOR ON WNBQ

6:45- 7:00 am	Town and Farm
7:00- 9:00 am	Today (four local segments in color)
12:00-12:30 pm	Noontime Adventures with Uncle Johnny Koons (children's program)
12:30-12:45 pm	Kenny's Klub (children's program)
12:45- 2:00 pm	Bob and Kay (musical variety) with Eddie Duocette (cooking demonstrations)
2:00- 3:00 pm	Matinee Theatre (NBC)
4:30- 5:00 pm	Howdy Doody (NBC)
5:00- 5:30 pm	Elmer the Elephant and John Conrad
5:30- 6:25 pm	Adults Only (musical variety) including 5 min. spots on news, weather and sports
10:00-10:10 pm	Weather Man
10:10-10:15 pm	Dorsey Connors Show
10:15-10:25 pm	Jack Angell and the News
10:25-10:30 pm	Let's Look at Sports with Norm Barry
10:30-11:00 pm	Mon.: RCA Color Theatre; Thurs.: Kukla, Fran & Ollie; Fri.: Walt Worlisky's Workshop

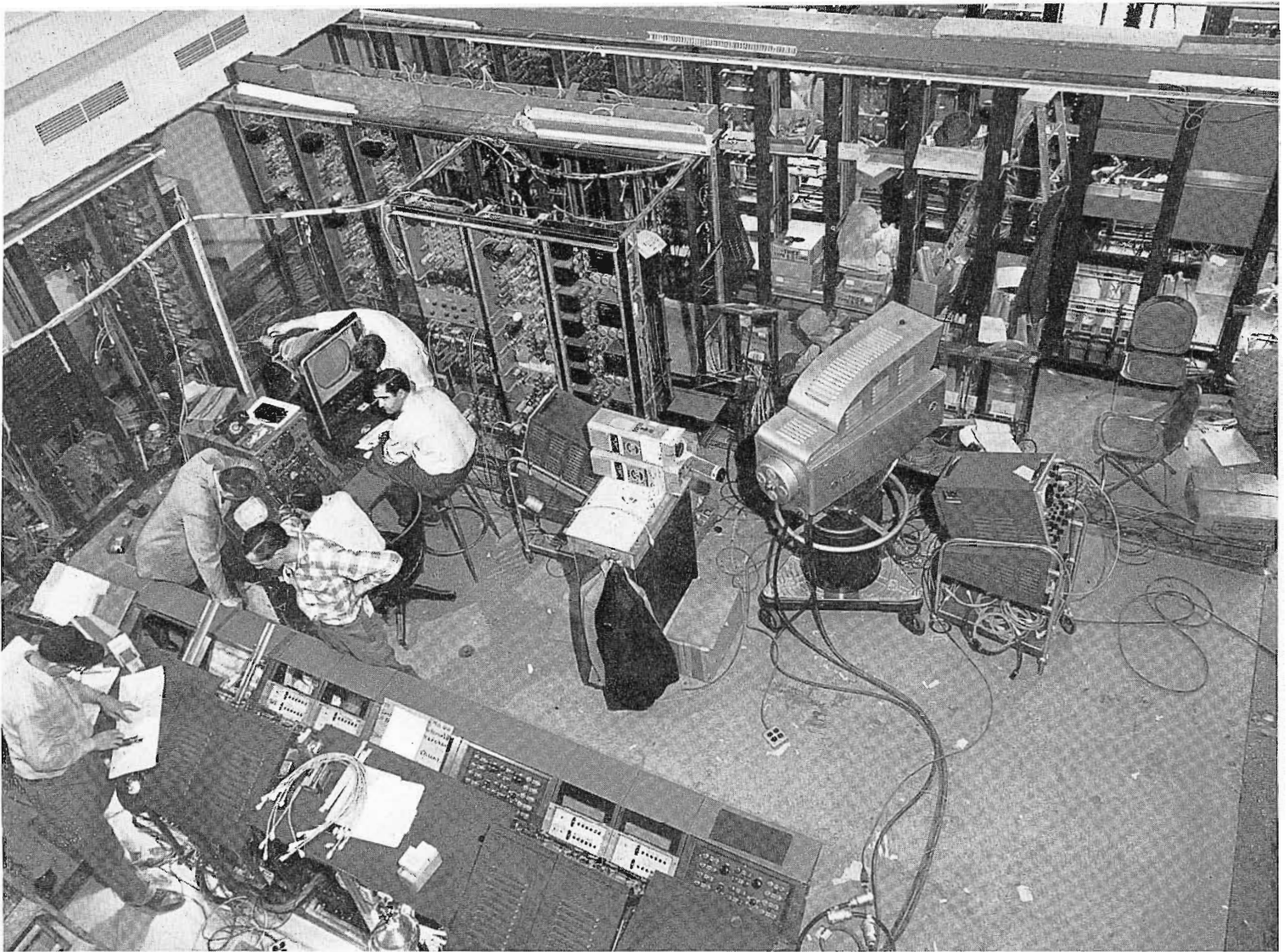
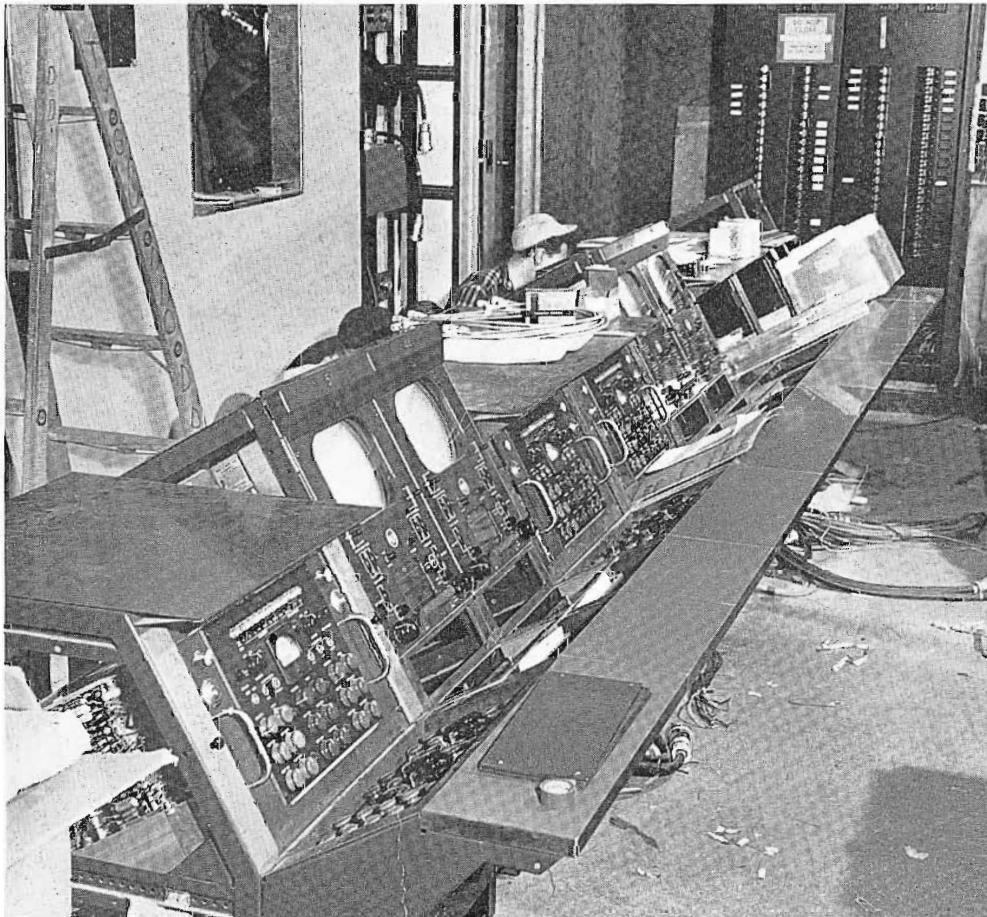

FIG. 3 (above). WNBQ's "video central" as it looked on March 22 (three weeks from C-day). Five studio camera controls are in console at lower left. Two film camera controls will be in a smaller console, the housings for which can be seen just behind the color camera. Camera auxiliary equipment, switching equipment and distribution equipment will be located in the three rows of racks at the top right. The camera control around which the men are grouped, and the three racks to their right, were temporarily located in this position and have since been removed.

FIG. 4 (below). Front view of the studio camera control console at WNBQ. As completed it consists of five processing amplifiers and five TM-5B Monitors with auxiliary panels (one of each for each of the five color cameras). Waveform monitors will occupy the space on top of the processing amplifiers. Color monitors will be mounted in the open spaces in the wall at left.



dissolves and special effects is incorporated as an integral part of the system. Thus "special effects" becomes a part of regular programming facilities.

Probably the most interesting part of the WNBQ installation to visiting engineers will be the "video central" which is a single large room in which are installed all of the color camera controls and the equipment racks which contain the auxiliary camera chain units, the switching and distribution units and the power supplies. Two views of this room (which was the "old master" control room of NBC Chicago) are shown on the following page. These show the new "video central" as it appeared on March 22nd (three weeks before C-day). Many equipment units were not yet in place and there was the usual littering of packing boxes, wire ends and tools. However, enough of the equipment can be seen to get an idea of the general arrangement. At the present time the control positions for the five live cameras are incorporated into a console running across the front side of the room. Later the film camera controls will be moved from their present position (in the film center) and

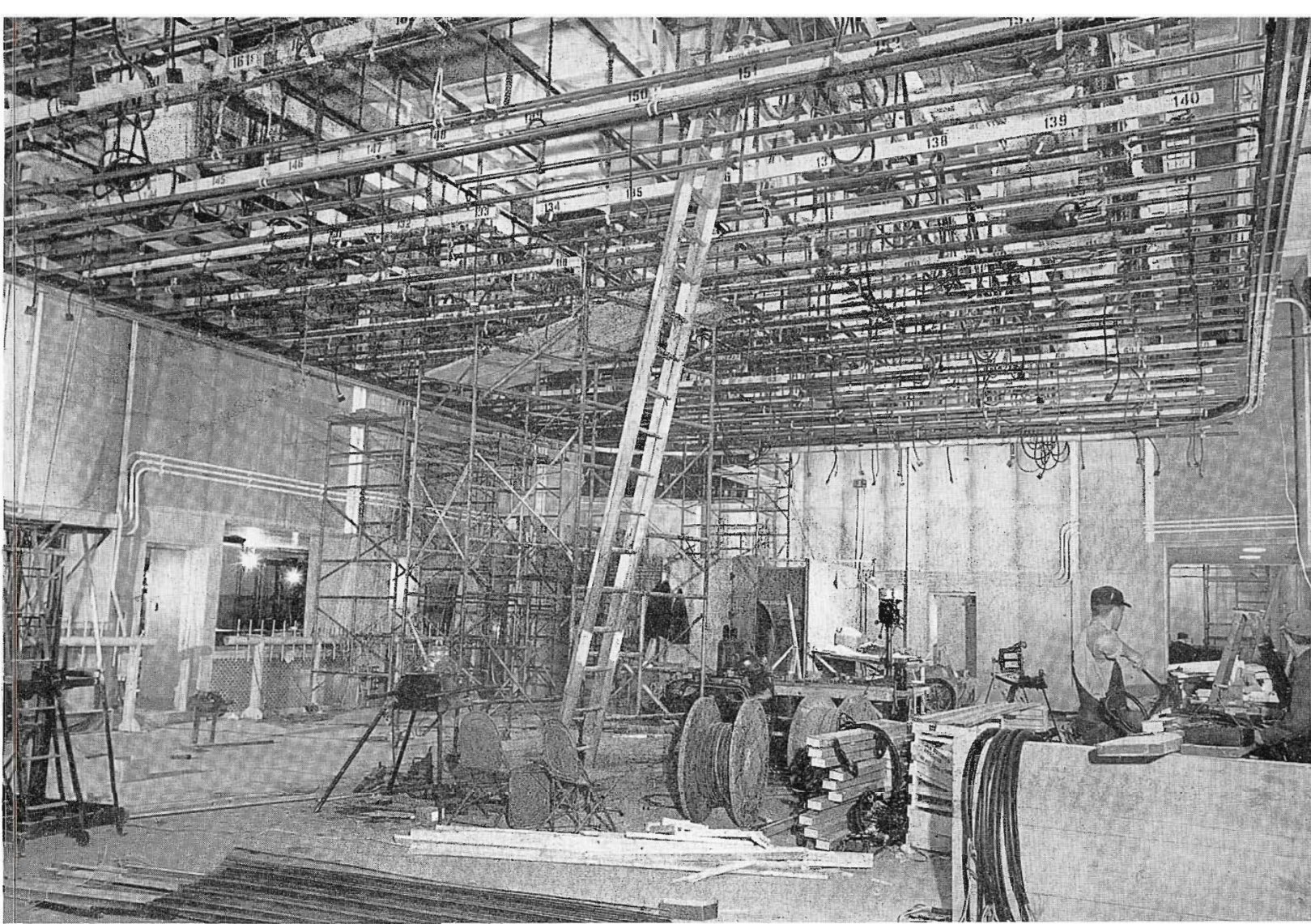

FIG. 5 (above). WNBQ's Color Studio A as it looked on March 22. Lighting outlets were completed and scaffolding was coming down. This view, made just before lights were hung, shows the very large number of battens provided for hanging lights and scenery. All battens are suspended on ropes which run over sheaves and down to the pin rails along the side of the studio (left center). Every fourth batten is for lights, others for props. Arrangement makes it possible to use any part of the studio area for staging. Rail type hanger for cycs runs around all four sides of studio.

incorporated into this single camera control position. Racks are arranged in three rows behind the control position.

The studio control booth, located adjacent to the studio, contains extension monitors for viewing the various camera pictures, the director's console, the TD's console and audio console. Placing the camera video controls in the "video central" made it possible to reduce the usual crowding of the studio control room. It is also believed that it will result in better and more efficient color operation. It is one of the features of the WNBQ installation which other stations will be interested to see.

The WNBQ color installation, of which additional views are shown on these pages, was planned by NBC engineers of the O & O Division, working under the direction of Charles Colledge, Director of Engineering and Technical Operations, O & O Division. Installation and construction work was supervised by Ed Nolen of the NBC Video Facilities group. Howard Lutgens, Manager of Technical Operations for NBC's Central Division, will be in charge of the technical operation of the color installation.

FIG. 6 (below). View in WNBQ's new power supply room which is located on the floor above the "video central". SPU's for all color video equipment are located in this room on eighteen racks (arranged in three rows). In this view, which shows the room before all units were mounted, the new RCA WP-15 Power Supplies can be seen on the racks in the foreground.

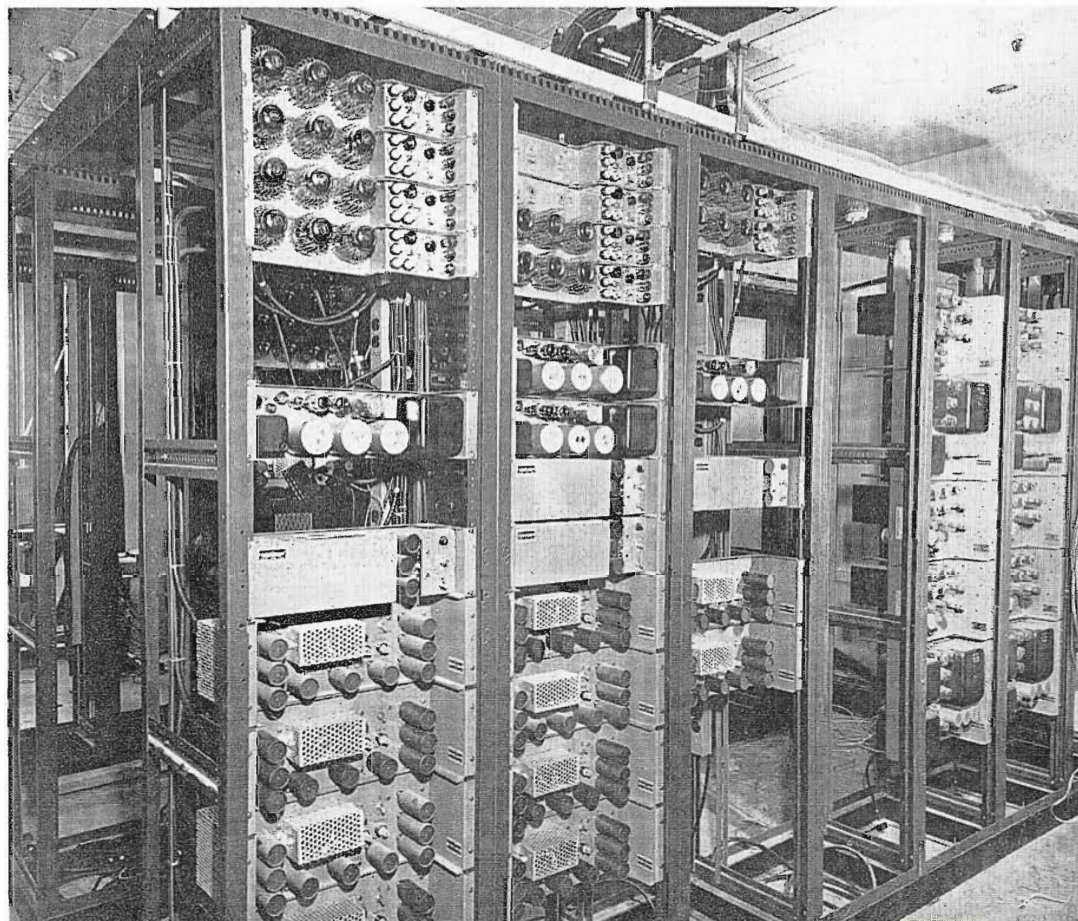



KMTV brings CO

by **R. J. SCHROEDER**
Chief Engineer, May Broadcasting Co.
and
P. A. GREENMEYER
Managing Editor, BROADCAST NEWS

**Uses Multi-Camera
Live Color with 3-V
Color Film System
to Air More than
100 Color Shows
per Month**



FIG. 1. Earl May, President of May Broadcasting Company, owners of radio station KMA at Shenandoah, Iowa and KMTV at Omaha, Neb.

On its sixth anniversary as a TV station, September 1, 1955, KMTV took steps to prepare for its color future. Within two weeks a live color camera had been purchased and by the end of the month the first color program was telecast. The next month a regular daily schedule of live color shows was inaugurated. This has been increased to the point where in March, 1956, 66 local shows were programmed, in addition to 56 NBC network shows, making an impressive total of 122 color shows for Omaha in a single month.

Is Color Good Business

What is the reaction to all this local color activity? For one thing it appears to be an excellent business venture. Management and sales are convinced that it's a step in the right direction. Station personnel are putting on color programs with dispatch and quite a bit of enthusiasm. Of most significance is the fact that local merchants are buying spots in, and segments of, practically all live color shows. Although higher rates are charged for color, this has been no detriment to its acceptance. All in all, it looks as if KMTV were repeating its successful business ven-

ture of 1949, when it was among the first in Omaha with TV.

Not satisfied with merely procuring one live color camera, the second was obtained during the second month of color operation. Experience with the first had shown it was not difficult to handle and, of more importance, the second was needed to attain the quality of production that can only come as a result of multi-camera operation.

Foresight and faith in the future of color TV have led to the tremendous step that the management has taken. It is axiomatic that color will soon be big business. According to the KMTV color timetable no more than one year will see the great trek to color. Complete color facilities were installed, in order to obtain the know-how that will enable KMTV to take advantage of the opportunities offered by color.

Management of the station has always been characterized by progressive outlook as well as keen business sense. The May Broadcasting Company, which owns KMTV, took its original plunge into television in the days before the freeze. At that

LOR TV to Omaha

time the company operated (and still does) radio station KMA at nearby Shenandoah, Iowa. Acting upon the shrewd observation of its management, the company was among the first in Omaha with television and has maintained an enviable position in the industry ever since.

Station operations began August, 1949, putting 12-kw effected radiated power on the air. The station expanded September, 1953, to 100-kw erp. The station operates on channel 3 and is an NBC affiliate.

KMTV serves Western Iowa, Eastern Nebraska and parts of Kansas, South Dakota and Missouri as well as the local Omaha-Council Bluffs area. Although in different states, Omaha and Council Bluffs are directly across the Missouri River from each other. Omaha has a population of approximately 300,000; Council Bluffs, 120,000. There is no station in Council Bluffs.

The first step toward color was taken Dec., 1953, by equipping for transmission of network color. The first local live colorcasts began Sept., 1955. Color film and slide facilities were added Jan., 1956.



FIG. 2. Frank Fields displays color catalog of May Seed Company to illustrate point in his thrice weekly color program "Over the Garden Fence."

Color Commercials

Three weeks after going on air with color, KMTV aired its first full color commercial. Sponsored by Monte White, Inc., a local automobile agency, the five-minute commercial featured Mr. White's description of the new 1956 De Soto while the car revolved on a giant turntable (Fig. 4).

Before Christmas a commercial live color program featuring gift suggestions was produced four weeks in succession on Tuesdays from 9:30 to 10 p.m. There were ten participating sponsors, representing local department stores. A higher rate than the regular monochrome charge was made and accepted. Results of the commercial color venture were excellent, both on color and monochrome sets. Programs were well received, and sponsors unanimously reported that response was good.

Five commercials are put on daily during the morning kitchen show. Spots are smoothly inserted and the "pitch" is made within one minute (Fig. 5).

Color slide and color film commercials are employed by the May Seed and Nursery Company in its Monday-Wednesday-Friday live color program (Fig. 2).

Owen Sadler, Executive Vice-President and General Manager, reports: "We charge straight rate card plus what other extras are necessary to cover special artwork, sets, or other production factors involved. Our experience thus far indicates that these extra charges amount to approximately 30 per cent over the regular rate card."

Live Color Programming

Two half-hour live color programs are put on Monday through Friday at 9:30 a.m. and 1:30 p.m. "Your TV Home" in the morning features the latest in the culinary art. "Better Living" in the afternoon is made up of three 10-minute segments:

1. Exercise and beauty hints for ladies,
2. Latest in fashions, or panels featuring prominent guests, and
3. Home economics (Fig. 3).

The daytime local color line-up also includes Frank Field in "Over the Garden Fence" each Monday, Wednesday and Friday for 15 minutes beginning at 1:15 p.m.

Omaha saw its first local TV opera on April 7, when the original set and the full cast of the Omaha Lyric Theatre were used in the production of "The Prodigal Son."

KMTV produced this masterpiece and hour-long drama as a live color show. As far as is known this is the first production of an opera in color by an independent station. It was sponsored by Kilpatrick Department Stores and all commercials were also put on in color.

The daily color fare includes NBC Matinee Theatre and Howdy Doody. Also the Spectaculars, Milton Berle and all other NBC color shows. Together with weekly KMTV color film shows, this makes an impressive total of more than 100 color shows per month—an average of four daily.

Color Film Programming

There are two one-half hour color shows weekly: Travelogues called "Colorama." These are presented by the station on a sustaining basis as both a public service and in an endeavor to arouse interest. Plans call for showing feature color films after time is sold, and already the station has booked its first feature, "Alice in Wonderland," in confident expectation of the awakening awareness of the potency of color. Color film and slide commercials are also used as inserts in various local live color shows that run on weekdays.



FIG. 3. Sets for "Better Living", a 30 minute color show Monday through Friday. Show divides into three segments, each with separate set.

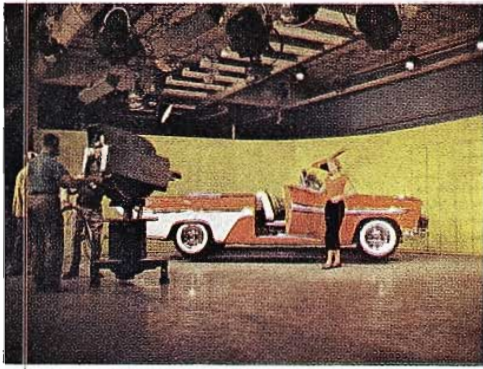

FIG. 4. First color commercial put on by KMTV was sponsored by local car dealer.



FIG. 5. Color kitchen show "Your TV Home" runs 9:30 to 10:00 am Monday through Friday.



FIG. 6. Thanksgiving show was one of the first color extravaganzas put on by KMTV.



FIG. 7. First colorcast by KMTV. This featured a United Fund Campaign drive at the local convention hall. There were no rehearsals.



FIG. 8. Typical KMTV advertising and promotion for its color TV facilities.

Color Promotion

For its first locally produced color program, KMTV bypassed commercial possibilities in favor of public service. Called "The Newest Look," the area's first colorcast spotlighted Omaha's first United Fund Campaign. The half-hour show received a great deal of favorable comment from civic leaders and businessmen although it went on the air without any advance planning or rehearsals (Fig. 7).

KMTV had a color clinic for TV servicemen in conjunction with nearby set distributors. Visitors to the clinic toured the studios, watched production of a live color show, and saw themselves in color on a closed circuit TV demonstration. Color clinics have also been held for agencies and advertisers. Station personnel used the RCA special effects generator to give commercials more punch in these clinics.

On the day the contract was signed for a live color camera, the news went out that night over the air that KMTV had taken steps to bring local live color to Omaha. In local newspapers and in the trade press the station inaugurated a special color campaign. Large advertisements notify viewers of all phases of color progress. Over 25 newspapers in the area carry the station program schedule, and all make special note of color programs. In all important trade magazines, two-color adver-

tisements have spotlighted the station as the color leader in its area (Fig. 8).

Each month, there is sent a complete color program schedule to color set owners, distributors and dealers, also to advertising agencies and KMTV national representatives. The color mailing list now totals over 600 names (Fig. 8).

National and local sponsors have been introduced to the immense commercial possibilities of color television by KMTV. Several clients have checked their products on color television. Some have already started redesigning packages as a direct result of color TV testing.

For outstanding color programs such as Peter Pan, KMTV has contacted color set distributors to arrange a special color open house at their dealers. In the case of Peter Pan, hundreds of persons took advantage of the invitation of 17 dealers in Nebraska and Iowa to see color television for the first time.

Color television has been further promoted by management via window displays, new program schedules, new stationery, etc., all featuring the insignia of Color Television Center, KMTV.

Although the station is not actively seeking color commercials, but doing more in demonstrating to others and getting experience for itself, some advertisers have insisted on purchasing color commercials.

Advance Preparation for Color

Members of the staff attended RCA Color Seminars. Network color equipment was installed in 1953, and at the same time some RCA color test equipment was procured: Color monitor analyzer, linearity checker, color signal analyzer, square wave generator, convergence dot generator, and color bar generator.

One man was assigned the specific job of familiarizing himself with color techniques. His was the job of learning how to use this color test equipment. He was made responsible for the network color programs. All data, instruction books, and color problems were funneled through him. He also attended the RCA Color Seminars.

Along with color frequency standard equipment and a colorplexer, KMTV had a color test pattern on the air and a source of color signal for closed circuit work so that the engineers could become acquainted with color. This approach has paid off well and now the results are being reaped as the station is getting on the air unusually fast with color programs.

Plunging into Color

These people created a rather tough assignment for themselves because they set up an almost impossible program of color scheduling. One week after arrival of the first live camera they were on air with color. The next week they started a daily schedule of color shows. Immediately after were local demonstrations and color clinics. For these first attempts viewers were going to be critical and since there was no previous experience to guide them, station personnel had to be right the first time—and they were.

How did they achieve such speed and excellence?

First there was the basic philosophy of management, that of multi-camera operation. Also, choice of one man to specialize in color. Of equal importance was the spirit of enthusiasm that permeated the entire management and operating group. Pioneering and promoting of new ideas has been the life blood of KMTV. The same logic and confidence that spurred the initial plunge into TV, when others were holding back, has been the goading force of the plunge into color.

To be first in color, and to be there with good programming and picture quality were the goals. Here's a look at how it was done as told by the staff after the first few months of color operation.

FIG. 9. Color Wheel, developed by Art Director Bill Fries, shows at a glance the value of many colors on the grey scale.



Selecting Colors for Shows

Of course, the prime guiding principle in selection of color backgrounds, costumes, and properties is that the picture appear satisfactory on both color and monochrome receivers. The ultimate picture in the home is the acid test. If it looks good, then the color has been well chosen. How does one go about making a satisfactory selection?

In the case of KMTV the trial-and-error method was tediously employed for a sufficient period to build up adequate data to guide all future shows. This was accomplished by placing numerous colors, with their shades and tints, before monochrome cameras along side of a standard grey scale. Then each color was marked as to its registration in the grey scale. By this means some 200 colors were graded by station Art Director Bill Fries. From this information he designed and built a color wheel which shows at a glance the value of any of these colors on the grey scale.

Color Wheel

The color wheel has proved to be of material assistance in guiding the artists who prepare artwork, commercials, slides and backgrounds. It helps save time when planning shows. Much of the time that would be required to make up a test set—handling furniture, scenery, and costumes, is eliminated. From the wheel it is known in advance how certain colors will go together, and whether there will be sufficient separation on the grey scale. By this means it is possible to control contrast and to have a display of the possible choice of tones in between (Fig. 9).

Color Art

"Our experience," explains Bill Fries, "has indicated that art is easier to plan and execute for color TV than for black and white TV. Today, however, we are confronted with a problem in that the color presentation must also look good on a black and white screen. Our grey scale comparison, the color wheel which we built and the Munsell color book are great helps in this direction.

"We use colored paper stock a great deal for live art and also for slide artwork. Colored leaf applied by a hot press is very useful in making slides. In picking color combinations we use our Munsell Book of Color. We also view the match through the color camera system since this gives us the range of the color equipment."

Color Sets

"We have set up a few handy principles, in cooperation with our production and engineering departments, which we go by in preparing our sets for color shows. In general we keep our backgrounds 'greyed down' and put more 'chroma' in the foreground in order to get most pleasing three-dimensional effect. In a small studio we find that the background-foreground separation can be readily effected with lights.

"We have discovered that muslin-covered flats make excellent and inexpensive backgrounds. We paint them rapidly using Casein paints put on by roller applicators. No decorations are applied to the flats. However mobiles are sometimes used. We also find that drapes make rich and pleasing backgrounds for color presentations.

"In all our set preparation for color shows we give ourselves plenty of time to work out the colors and other details of construction.



FIG. 10. Lighting for color kitchen show. Fluorescents are holdover from monochrome.

"We work closely with the engineers in order to know equipment capabilities so that our sets are reproduced by the color system into a pleasing and attractive picture in both color and monochrome."

Props for Color Shows

"For our color shows we obtained some new props because the ones we had been using for black and white were not always suitable," reports Production Manager Lew Jeffrey. "Since there was nothing to go by, we tried out different combinations on the color camera. At the outset our combinations were not always good, but we are getting experience; it's becoming much easier to get good results."

Rehearsals for Color Shows

"For our regularly scheduled live color shows," reports Director John Reinemund, "no rehearsals are necessary. Only when new talent is used, or visitors are interviewed is it necessary to do anything in advance. Even then people running the shows usually guide the newcomer. No formal rehearsals are held. It's merely a matter of advising the newcomer about dress and helping with makeup. Ladies are usually told to bring several dresses and to use ordinary street makeup. Men are simply advised to wear colored rather than white shirts.

"Live commercials for color shows are always rehearsed."

Makeup for Color

"We are attempting to standardize makeup for color shows," asserts Director Reinemund, "by having about six standard types. We find that quite frequently the ordinary street makeup used by a person is suitable. Most of our work is to correct for skin defects or to balance two different skin tones. Color makeup poses neither serious nor impossible problems."

Color Lighting (Fig. 10)

"Lighting for color simply means pouring more on," explains Assistant Chief Engineer Wally Schwentser. "For example, on our kitchen set we normally use 250 foot candles for black and white. For color we increase this to 500 foot candles.

"Monochrome lighting of this kitchen set consisted of 120 foot candles of vertical lighting, supplied by fluorescents in the ceiling, and the remainder horizontal lighting from a few scoops as required. For color the fluorescents were cut out. Six scoops of 1,500 watts each are used for front lighting, eight 300-watt spots are used for background lighting, and six 300-watt spots are used for vertical lighting."

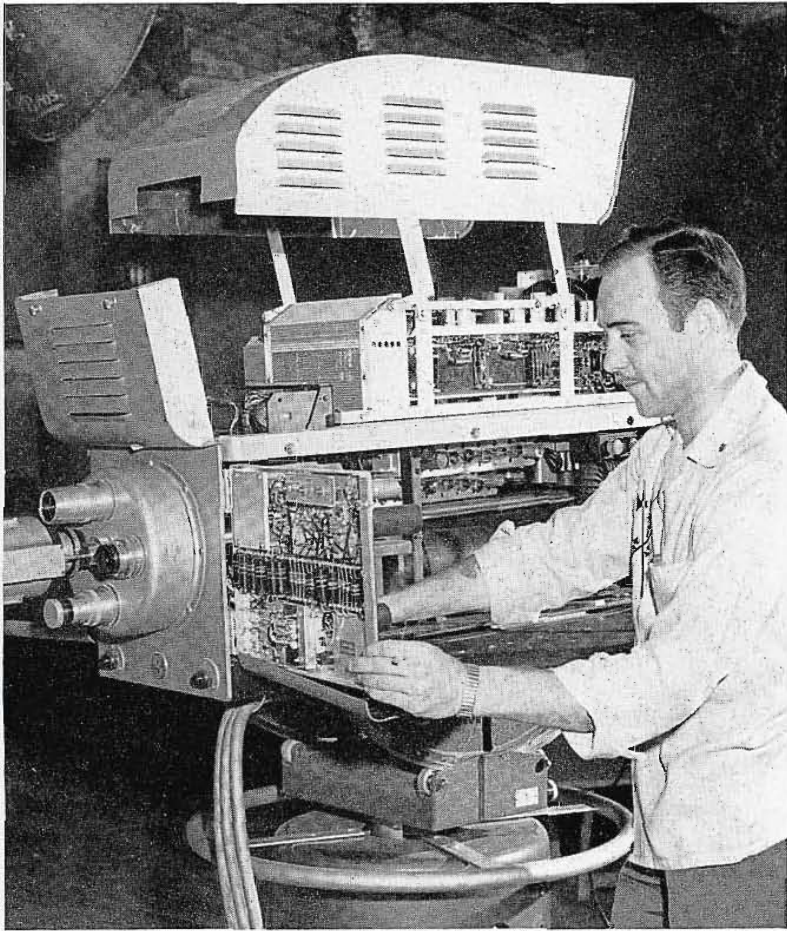

FIG. 11. Set up time for color camera now takes approximately one hour, but should be reduced to half that time as engineers improve their efficiency.



FIG. 12. Operating position in studio control room for two color cameras.

Operation of Color Cameras

Approximately two hours are required each day for setting up the color cameras, however, a considerable amount of this time is currently used for teaching purposes. When all personnel have become familiar with setup and operating procedures, it is expected that one hour will be saved by elimination of the instruction period. In addition, it is expected that 30 minutes will be saved by improving efficiency as the engineers become expert in the setup routine. Altogether this should reduce setup time to about one-half hour. Once the color cameras are ready for the first show, they are kept running until the last live show is finished. They are never shut down and fired up again.

Integrating Color into Black and White

The ideal sought for here is push-button type of switching from monochrome to color without having two complete and duplicate systems. This means it should be possible to switch from monochrome to color cameras at will and have available all special effects using but one system. There would not be equipment duplicates such as sync generators, monitors, and switchers.

Propelling force for this achievement is the savings in tube costs and manpower it would make possible. Using two completely separate and duplicate sets of facilities, both are kept running in parallel—

FIG. 13. Ideal schedule of camera operation, completely integrating monochrome and color operation.

WITHOUT INTEGRATION THE CAMERA SCHEDULE IS:

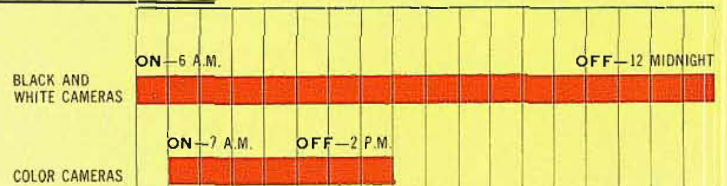

WITH INTEGRATION THE CAMERA SCHEDULE IS:

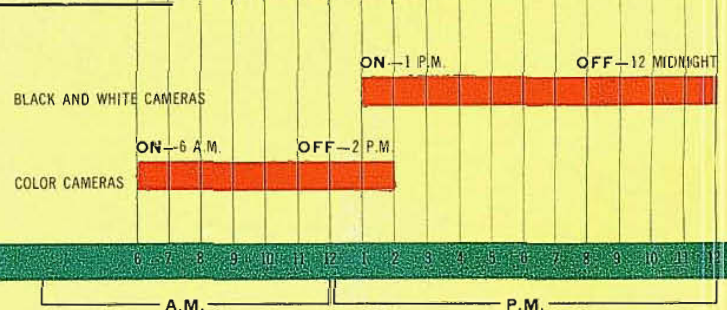

whether in use or not. Hence complete integration could save both in capital investment and in operating costs.

To illustrate the latter point, let us take KMTV as an example. At present there are live color programs from 9:30 to 10 am each morning and from 1:15 to 2 pm each afternoon. In addition there are monochrome shows before, inbetween, and after the color shows. It is desired to effect push-button integration so that color or monochrome output can be obtained as desired from the color cameras. Thus the ideal schedule (Fig. 13) saves seven hours on the monochrome cameras by adding only one additional hour to the color cameras. Savings are clearly visualized.

The Voice of Color Experience

The engineering staff expresses their professional attitude as well as that of management, when they state: "Under no conditions do we want the public to get the impression that we are going backwards as

we go forward into color. Since the great majority have black and white sets, this means that color shows should appear at least equal in quality to regular monochrome shows. To us this means three basic principles:

1. "We cannot go from multi-camera operation for monochrome to single-camera operation for color.

2. "We must have sufficient equipment to do color programming as smoothly and as professionally as in black and white. This includes complete system integration, because switching from color to monochrome must be accomplished without flopping of picture on the viewer's screen.

3. "Our color 'know-how' in programming and production, as well as technical, must be equal in quality to our monochrome know-how."

Building Location

Station KMTV is located in downtown Omaha, in the business district, at a place

which is the approximate center of the Omaha-Council Bluffs population area. The original building was a 2-story, masonry structure 50 by 130 feet purchased and modified for television operations early in 1949. An adjacent building, 50 by 135 feet, was added in 1953. Chief Engineer Schroeder designed the original layout, then later on integrated the second structure into the TV operation.

Station Arrangement

Studios and transmitter are both located in the same building, making a very convenient operating scheme. The tower is located only a few feet from the transmitter side of the building. Since it is situated on a hill, this incidentally makes a fine transmitting location. Furthermore, being in the business area of town makes it conveniently accessible for advertisers, employees, talent and procurement of props. Public transportation is at the door.



FIG. 14. Station headquarters in downtown Omaha. Office, studios and transmitter are all conveniently located here.

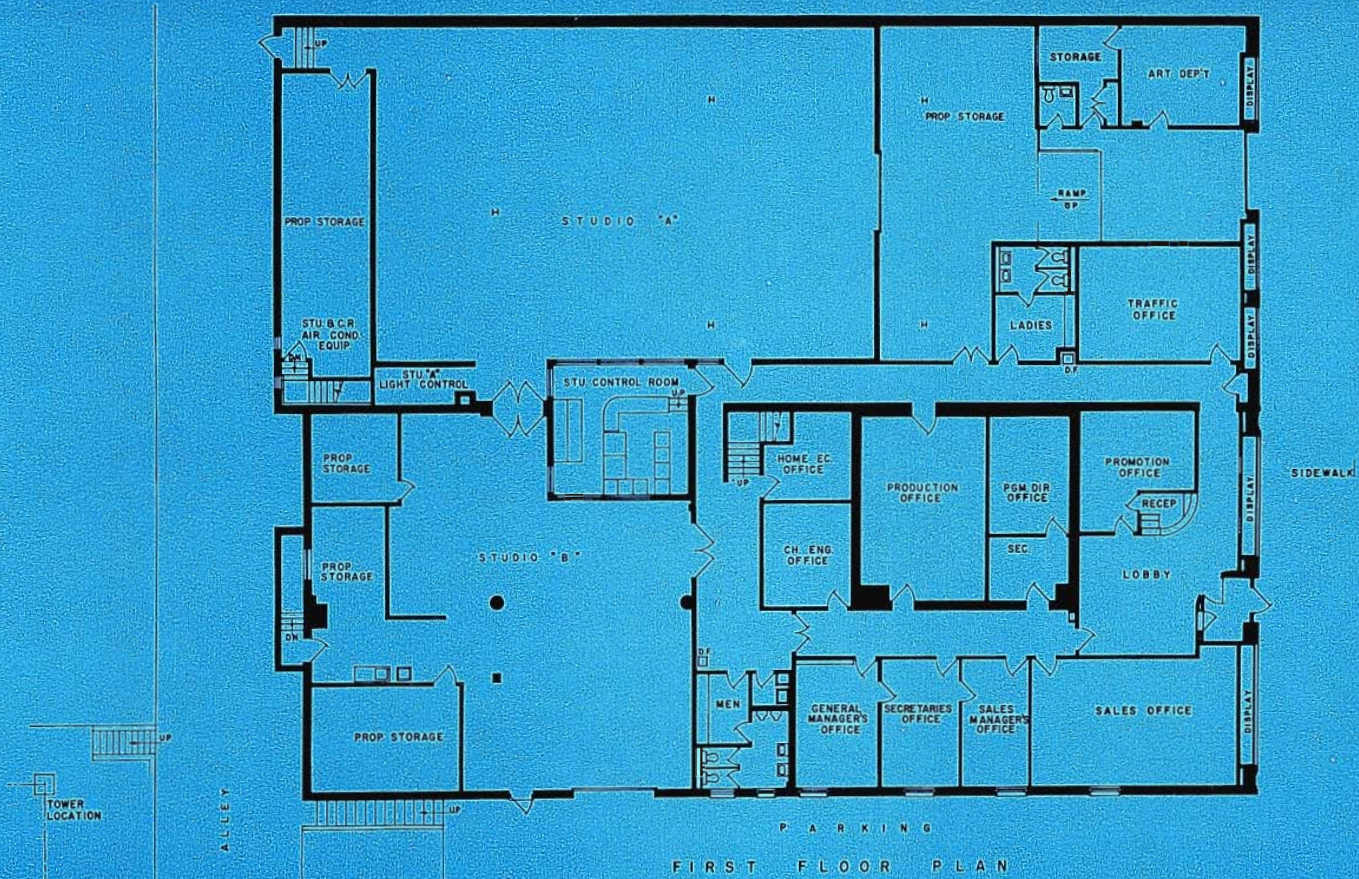

Studio Arrangement

Two studios are housed in the building as shown in the first floor plan (Fig. 15); these studios are adjacent and accessible to each other by a pair of swinging doors. A common studio control room is located between the two studios; also, a common light control room.

Each studio has a property storage area. In addition a general property storage and receiving room is located at the other end of Studio "A." This property room has a ramp leading to the street through an overhead garage door. It's large enough to drive large trucks into the building for unloading or into the studio for shows.

Studio "A," which is the larger of the two is 45 by 70 feet. In modifying the existing structure for studios the ceiling was formed by a layer of 2-inch rock wool blankets. Walls were furred with 2-by-2 inch studs on 16-inch centers, filled with insulating blankets, then covered with a ¼-inch composition board. For temporary shows, paper backgrounds are stapled directly to the board for one show after another until the board is "chewed away." At that time another ¼-inch layer is added and the process begins all over again.

Backgrounds and Sets

In general, paper is used rather than flats for transient shows. Windows and wall decorations are simply hung up, drawn on the paper with chalk or sprayed. There's no storage problem. A traveling drape arrangement makes it possible to cover these temporary backgrounds at will.

Permanent sets are employed for news, sports and kitchen shows. Actually there are a total of three kitchen sets in the two studios. Two of these are especially for color use and the third is in process of being converted.

Ventilation

The entire building is air conditioned. On the first floor 25 tons are used: A 15-ton unit supplies the studios and control room; 10 tons for office area. On the second floor 17 tons are used: 10 tons for transmitter room, projector room, audio-control and announcer's booth; 2 tons for audition room; 5 tons for film editing, news room and photo lab. These facilities have been designed to make adequate provision for full color operation.

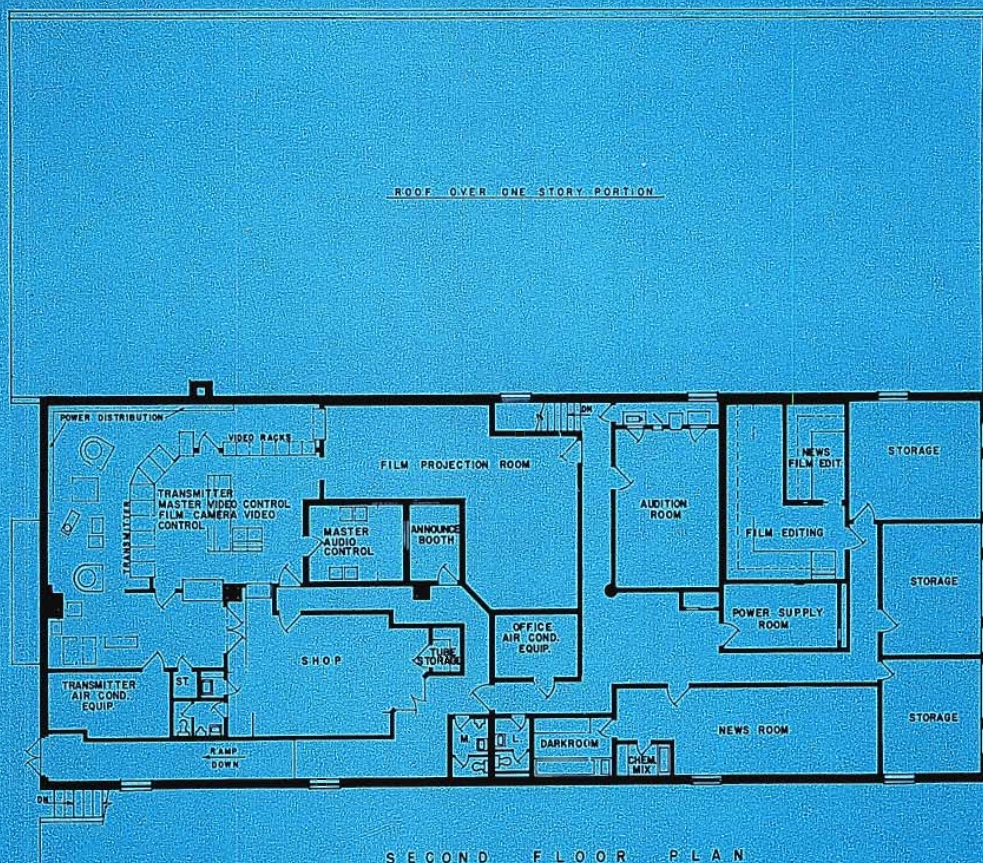

FIG. 15. Layout for station building, showing complete floor plans.

Lighting

Lighting is done in conventional segment fashion. There are six segments or quadrants. Daily shows have both permanent sets and lighting arrangements. Usually a single quadrant is sufficient for a permanent show. By means of a master switch the pre-set lighting of the quadrant is turned on. However, this pattern can be changed at any time by merely resetting the switches controlling the individual lights in the quadrant.

A conveniently separate room, between the two studios, houses power control equipment for lighting and convenience outlets. Each quadrant is controlled by 20 separate switches together with two masters. Each master controls a bank of 10 switches, for presetting and fast control.

The physical lighting grid construction was designed by the engineers. It consists of 1½-inch conduit hung from ceiling joists. Wiring is carried in metal raceways with removable covers. The ceiling is covered with insulation blankets; joists are indicated by battens holding blankets in place.

FIG. 16. Lighting for typical color show.

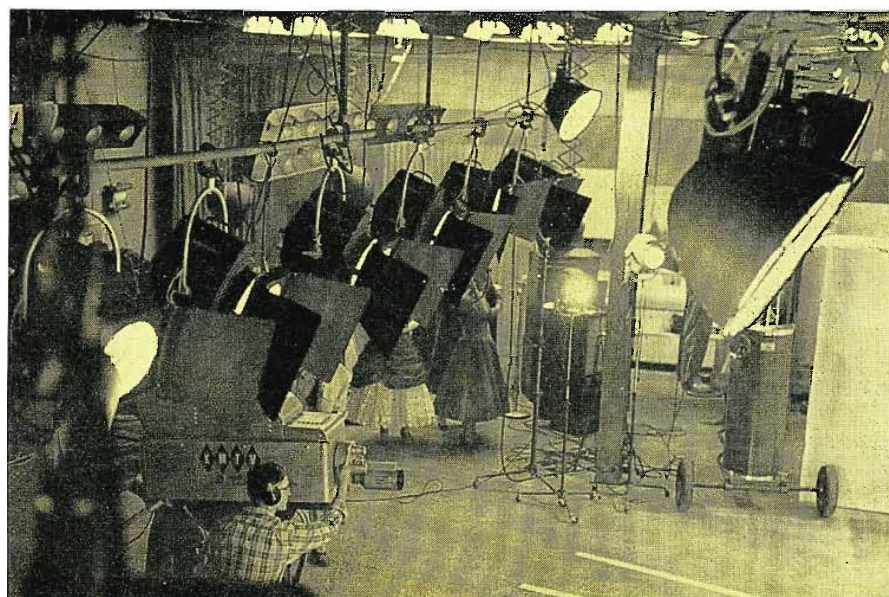

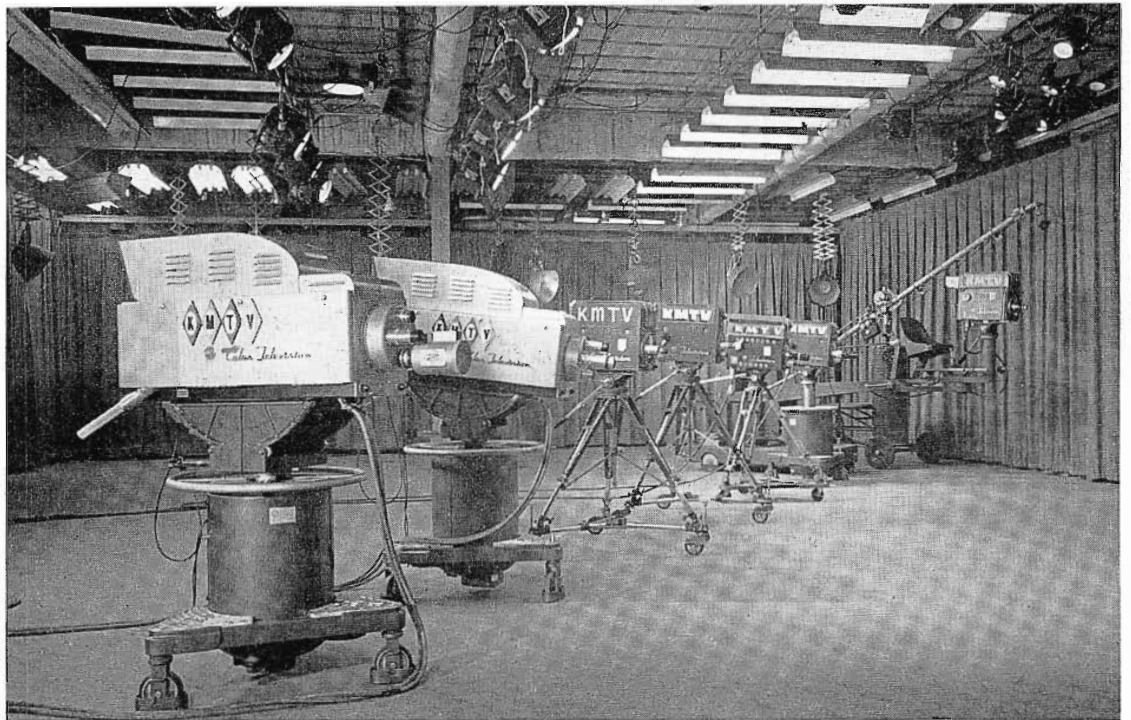

FIG. 17. Five monochrome and two live color cameras are available in the studios.

FIG. 18. Lower level of studio control room, showing video control equipment. At left, monochrome; at right, color.



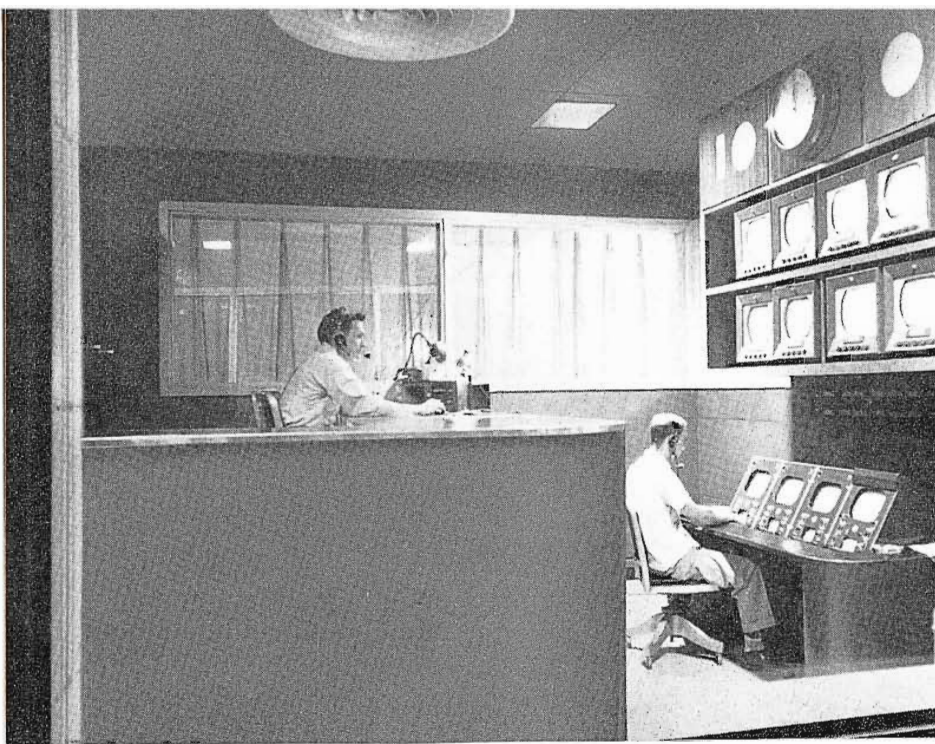

FIG. 19. Studio control room contains two levels. Upper level contains audio and video switching.

Studio Equipment

Five RCA monochrome cameras and two live color cameras are employed. Three of the monochrome units are field chains, the other two are studio chains. (Field equipment is mounted on a dolly so that it can be used in either the remote truck or the studio.) One large paramulator and five boom microphones are available. Also one Houston crane for TV cameras. These equipments can be used in either studio since they are adjacent to each other.

Studio Control Room

The common control room serves both studios. On one side is a window overlooking Studio "A," on the other side a window overlooking Studio "B." There are two levels in the studio control room, one 20 inches higher than the other. The upper level contains audio and video switching equipment. The lower level contains video control equipment.

The upper level is used by director, audio engineer and switcher. From this position the director can glance to the right or left, for watching operations in either studio. Directly ahead (and above the video controls) are the monitors. Hence this makes a convenient base of operation.

Monochrome and color camera controls form two separate positions on the video control level (see Fig. 19). In either case one video operator is employed. He controls the cameras in use for an on-air show or

a rehearsal. He can control either monochrome or color chains.

The bank of monitors show network, all film sources, each live camera (total of 7) on air and preview.

Control Equipment

The station engineers built their own switcher and fader equipment, using an RCA special effects generator. This gives 12 different wipes, inserts, and splits. Switching is direct, without relays, using standard RCA switch banks designed for video monitor switching.

The staff engineers designed, built and assembled the audio console. It contains 12 microphone inputs plus two turntable inputs. It includes pre-amplifiers, line amplifiers, monitoring amplifiers. Six pre-amplifiers are used for high-level mixing.

Color Control

For switching the TK-41 live color cameras and TK-26 color film camera, the engineers designed a switch box with 3 push buttons and 3 pilot lights. The lights indicate "on air" and are marked 3-V, CC No. 1, CC No. 2. By this means the video operator puts any of the three color sources on air. A special power panel was built to turn on all camera chains (7 monochrome, 2 live color, and a 3-V film system). All power supplies are remote and controlled by relays from this panel. It also controls power for master monitors, distribution and stabilizing amplifiers.

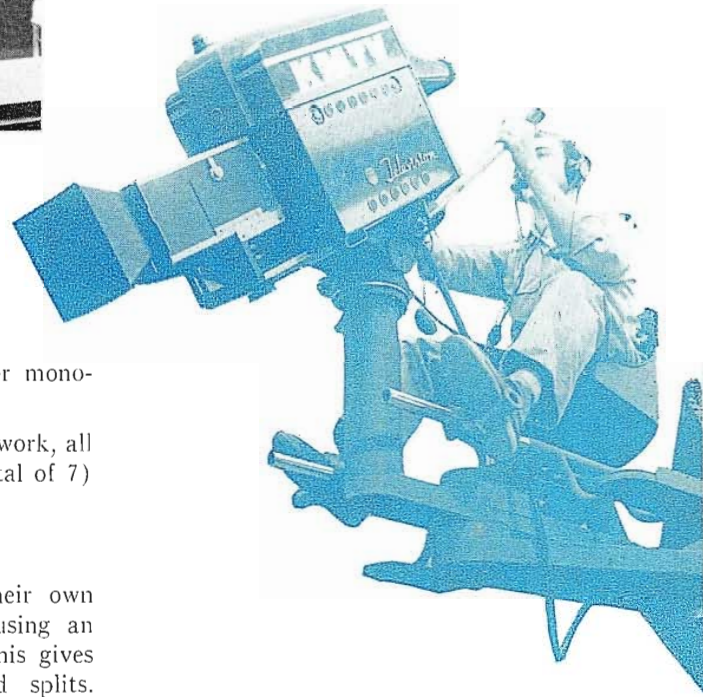

Master Control Concept

Studios A and B are adjacent, separated only by large doors and also by the central control room. This makes it possible to use common cameras. It also means that one control room serves both studios. (See Floor Plan, Fig. 15.)

Master control is in the transmitter room on the second floor. Thus studio shows are treated as remotes at master control. The film chains are looped through

FIG. 20. Block diagram of station equipment and arrangement.

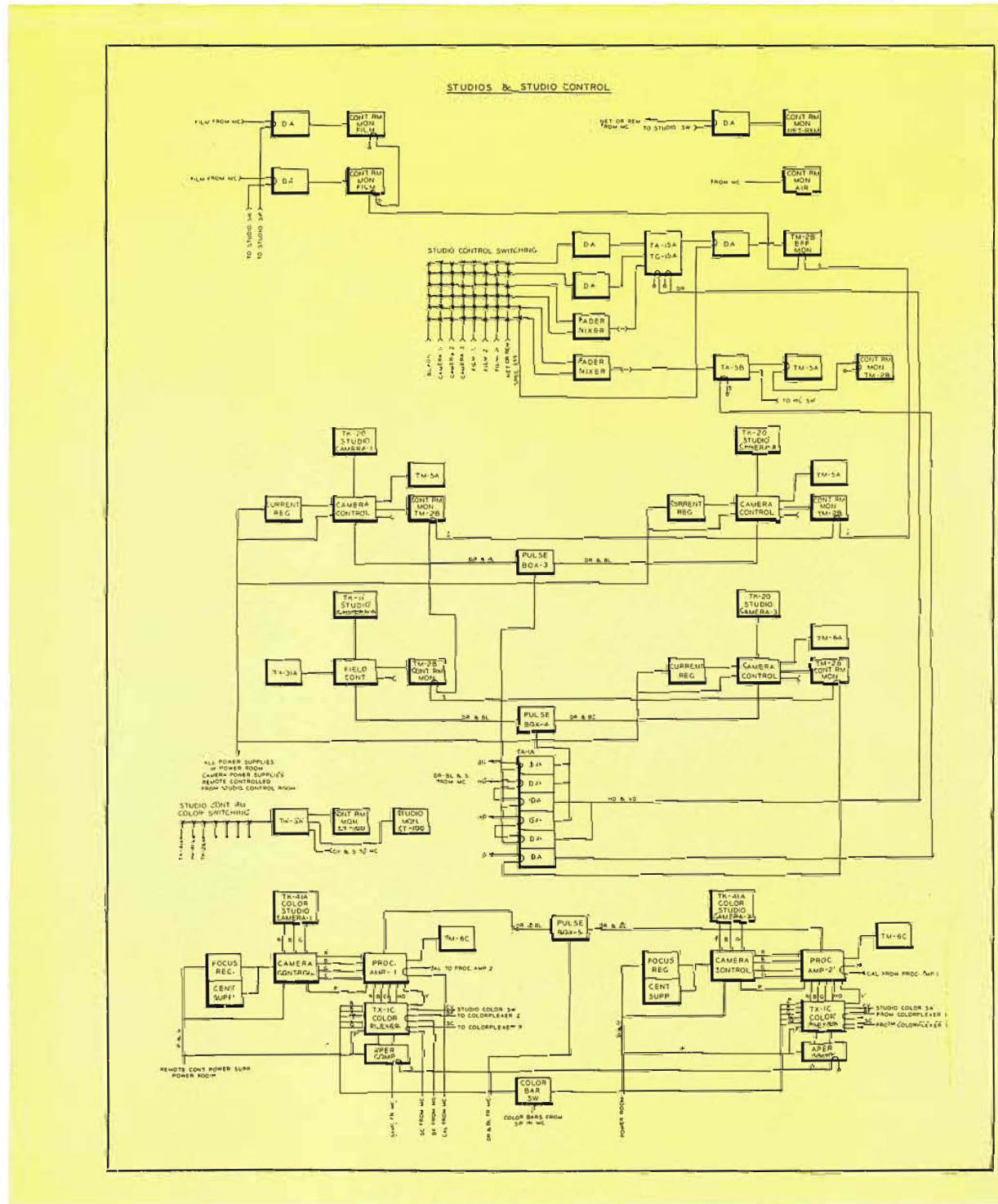

the studio control room to master control. (See block diagram, Fig. 20.)

This type arrangement has certain virtues. It means that network or film programs can be handled completely at master control, thus freeing the control and studios for other uses. It also makes the studio manpower available for maintenance, rehearsal, and setting up of next live show.

Although KMTV produced many live and ambitious shows from the outset, much

use was necessarily made of its film facilities prior to interconnection. This arrangement was of great help during the initial phase of operations.

This arrangement leaves all facilities in the studio control room available for director. Cameras, special effects, films or slides, preview or prefade—all are available for the director's use. If a film, net or remote show is on, he also has both studios available. If a live show is on, he still has the control facilities—plus the free studio.

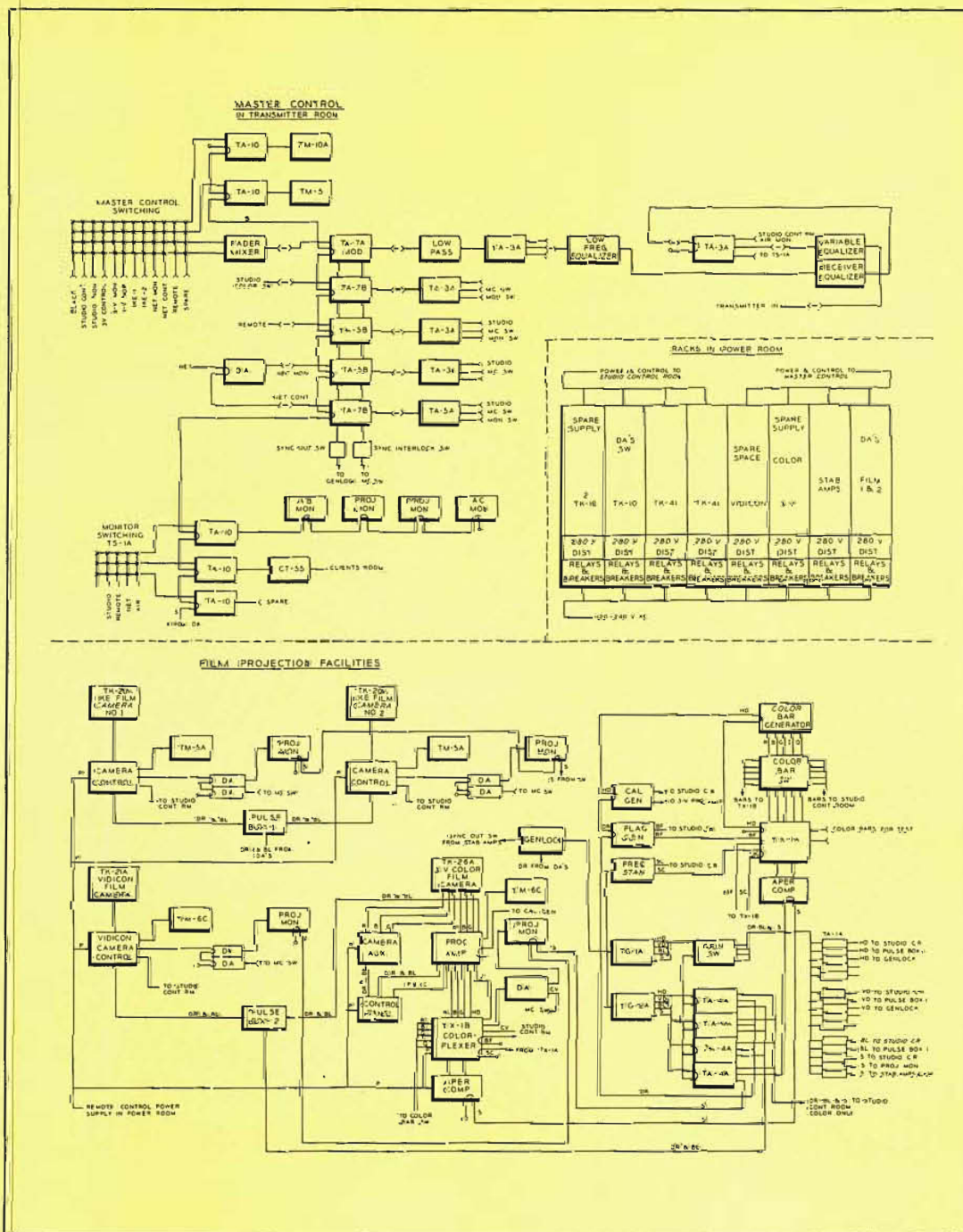



FIG. 21. This station has the first RCA 3-vidicon color film system employing the new TP-15 Universal Multiplexer.

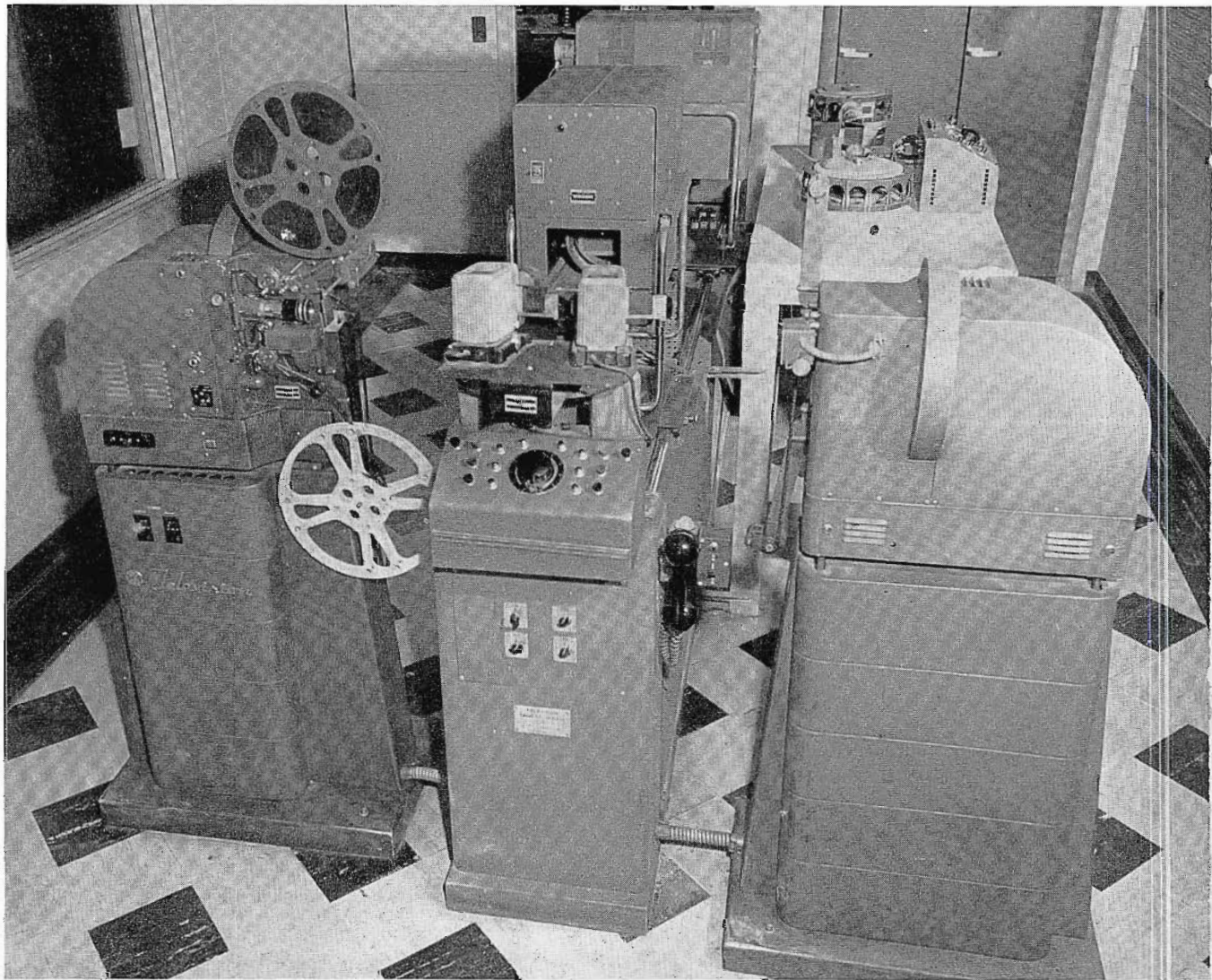
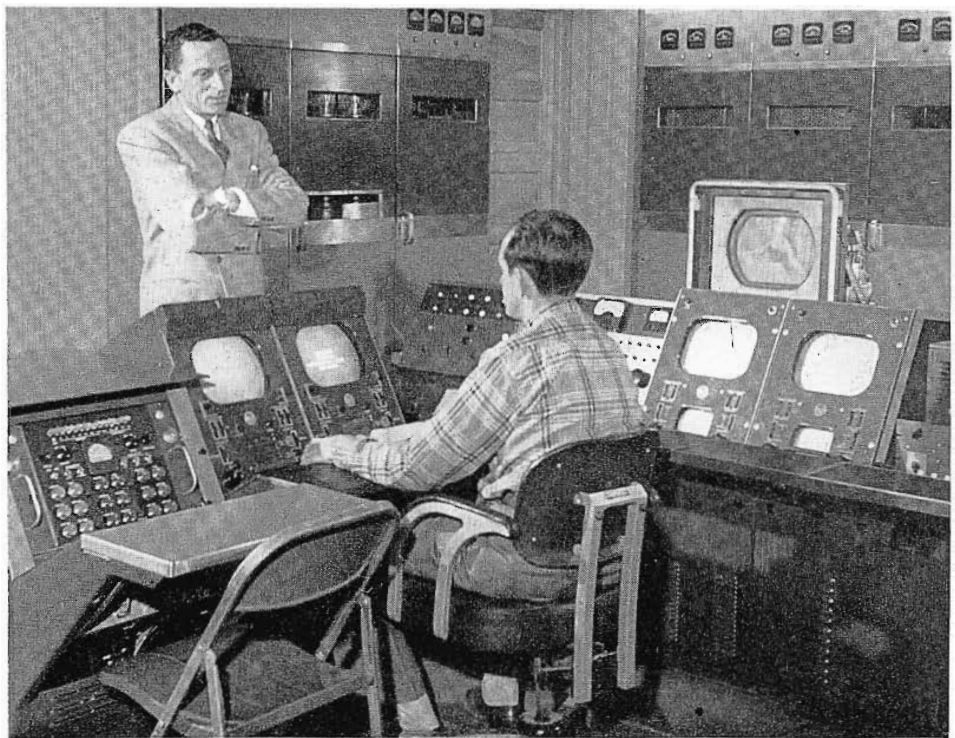

FIG. 22. Second film projection area employs two IKE chains, now in process of being converted to vidicon.

FIG. 23. Control console for 3-V film system is in transmitter room.



Film Projection Room

There are two complete film systems, one in each leg of an L-shaped area on the second floor (see Floor Plan, Fig. 15). One system consists of two iconoscope film camera chains. The other system is the integrated 1-V and 3-V system using the new TP-15 multiplexer (Figs. 21 and 22).

The No. 1 iconoscope chain uses two TP-16A 16-mm projectors multiplexed into the camera, with two 35-mm slide projectors that project directly into the camera.

The No. 2 iconoscope chain uses a multiscope for opaques, roll-arounds, and roll-ups; also a pair of 35-mm Selectroslide units working into a multiplexer. The Selectroslides are automatic projectors, each containing 16 slides.

A specially built remote control box enables the operator to perform start, stop, douse and changeover operations for the 16-mm projector. It also permits control of the two Selectroslide units, with Variacs in the circuit to dissolve from one machine to the other. Push button control from the box advances slide in off-air projector. There is a complete control box at each Ike position (see Fig. 22), to save the engineers from running back and forth. This gives complete control of all Ike inputs from either position and provides smoother operation.

The two Ike cameras are mounted on a Plett Labs TV camera bench. This permits the camera to be moved along the

length of the bench on rails and to be swiveled 360 degrees with 90 degree stops. This means new inputs can easily be added at any time. They are placed along each side of the bench. The Ikes are pushed into position and if necessary rotated to preset stop positions.

The station is in the process of converting the iconoscope chains to vidicon, because the projectors are locked to the a-c, 60-cycle line, hence sync generators have to be phased to these projectors in order to eliminate shutter bar. As a result it is not possible to procure complete system integration. Plans call for modifying the TP-16's, adding a TP-15 multiplexer and TK-21 vidicon film cameras. This arrangement can be integrated so that the entire system will work to color sync standards.

This planned arrangement will be used to put monochrome film shows on the air when the 3-V system is tied up for rehearsal. It will also be useful for running spots on short notice, especially if the same spot has to be repeated several times daily. Frequently there is not sufficient notice to allow time for splicing, or sponsors do not have enough copies available for splicing in at intervals, and in such cases the film can be loaded into this spare system and run as needed.

Color Film System

A completely integrated monochrome and color film system was procured late last

year. It consists of a TK-26 3-vidicon color film camera, TK-21 vidicon monochrome camera, Two TP-6CC 16-mm film projectors, a TP-3 35-mm slide projector together with the altogether new TP-15 multiplexer. (This is the type of multiplexer that can accommodate four inputs and two outputs. One of the four inputs will accommodate an accessory lens system for large opaques and live action commercials in both monochrome and color.) The KMTV system is the first employing the new universal multiplexer. Color film programming began in January of this year and has continued on a regular schedule ever since.

Control units for the 3-V film system are in the transmitter room at master control. A local control panel is also located at the multiplexer. All on-camera pictures are also monitored in studio control.

Film Editing Department

The KMTV Film Editing Department is one of the most modern and best equipped. It contains five 16-mm projectors, five complete rewind and silent film editing units, a sound-on-film editor, three built-in light boxes for single frame touchup work and sound track blooming, four splicers, and complete film-cleaning facilities.

The department also has storage space for 2000 film announcements, 1000 reels of program material and 4000 35mm slides.

As a service to the client or agency, the KMTV Film Editing Department will edit commercial film.

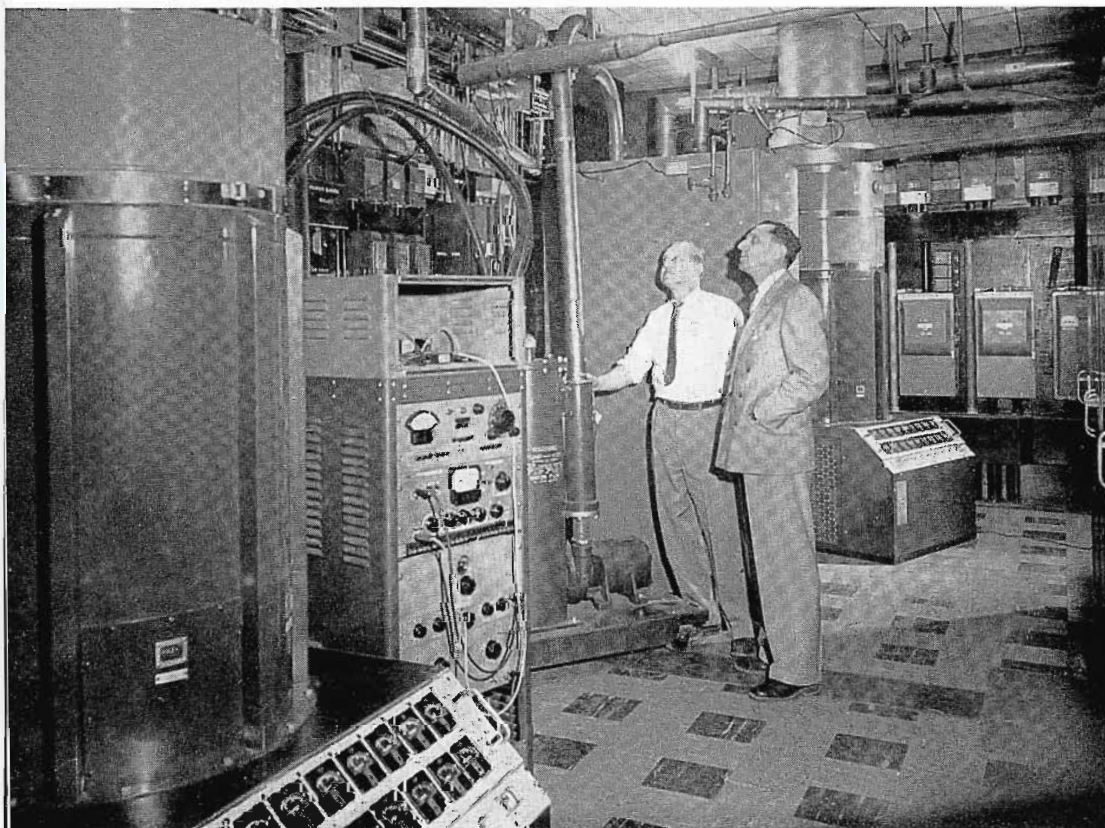

FIG. 24. KMTV uses an RCA TT-5A 5-kw VHF transmitter with a TT-25AL amplifier.

Transmitter Room

The transmitter and master control are located on the second floor conveniently adjacent to film projection room and shop. (See Floor Plan, Fig. 15.) It is roomy in the sense that there is sufficient space around all equipments for operation and maintenance. It is also compact in that both film systems, master control, audio control, transmitter, power amplifier, filters and announce booth are all accommodated in an area only 25 by 55 feet.

FIG. 25. Rear of the transmitter. Left, Assistant Chief Engineer, Glenn Kline. Right, Chief Engineer, R. J. Schroeder.



Transmitter Operation

To help the transmitter operator get back on air fast after a power failure caused by a blown fuse, a specially designed fuse indicator box has been built. These contain neon lights which go out when a fuse blows. They are being placed across all fuses, including 3-phase and all main switches. This means an operator can tell at a glance where his trouble lies.

The transmitter console features standard supervisory control, also film camera controls, video switching and intercom.

Transmitter Equipment

The station began operations in 1949, using an RCA Type TT-5A, 5-kw VHF transmitter. Expansion in 1953, added a TT-25AL amplifier. Together with a 6-bay superturnstile an effective power of 100 kw is radiated.

The racks of equipment in the transmitter room are arranged in form of a large "U" to obtain maximum utilization of available space. From left to right, facing the console, equipment is arranged as follows (see Figs. 23 and 24):

2 racks: Frequency monitoring equipment, limiting amplifier for audio, frequency meter, modulation monitor, and power supplies.

3 cabinets: TT-25AL audio rectifier, TT-25AL video rectifier, and TT-25AL audio control.

8 cabinets: TT-5A TV transmitter.

1 cabinet: TT-25AL control unit.

7 racks: Video patching, stabilizing and distribution amplifiers, sync generators, colorplexers and aperture compensators. Also rack-mounted equipment for film chains (and 2 racks in film projection room).

Directly behind the transmitter are located two TF-25AL amplifiers, one for video and one for audio. Also in this area are the vestigial sideband filter, diplexer, harmonic filters, TT-25AL plate transformers, power entrance and distribution, and transmitter room air conditioning equipment (Fig. 25). An engineering shop is directly adjacent to the transmitter area.

Antenna

Directly behind the station building rises a 450-foot tower supporting an RCA 6-bay superturnstile Type TF-6AL antenna. Total height is 550 feet to the beacon. The center of radiation above average terrain is 590 feet. Two 3/8-inch coax lines are used to feed the antenna.

When the station went to high power in 1953, the present antenna was installed. It was first assembled out in the country in order to make measurements and to familiarize the local contractor with assembly procedure. At actual installation the pole was assembled inside the tower, lined up, then welded. Using tower as a gin pole, the pole was raised through center of tower and mounted. Finally, bat wings and harness were installed. This was accomplished in approximately six weeks, with no time lost on air!

Central Power Supply Room

All power supplies are located in a power supply room on the second floor and are remotely controlled. Eight 10-foot racks house all power supplies and switching equipment. Each rack can contain 8 power supplies and a master switch (circuit breaker) to shut off the individual rack. A wall-mounted master switch disconnects all supplies.

Every rack is divided into four circuits, each of which is controlled by a relay. Power supplies in the rack can be plugged into any of these four circuits. Individual relays are controlled by remote toggle switches. These are located on panels in studio control, projector room, and transmitter room.

For ventilation, air is circulated by a 5000-cfm attic-type blower through a fil-

tered system with thermostatically controlled damper. Entrance air supply is pulled in from a roof-top duct.

System design uses maximum outside air during summer and will hold room temperature to approximately 10 degrees above outside air temperature. During winter a thermostat operates motor-driven dampers to control the room temperature and by recirculation of room air, the temperature is held at approximately 65 degrees.

Intercommunication

Intercommunication is provided between all operating positions at transmitter, studio, projectors, master audio, announce booth, and remote pickup position. The remote mobile unit has communication with operating positions at the station so that live commercials and film inserts can be controlled directly from the truck by the director.

Master Audio Control

This is between film and transmitter room; also adjacent to announce booth (see Fig. 15). Equipment includes RCA 76C console, two 70-D turntables and an LC-1A speaker for master control monitor. A tape recorder and TV monitor are also available. The console feeds the limiting amplifier which in turn feeds the transmitter. From this console it is possible to select film sound, studio, turntables, network, remote or announce booth.

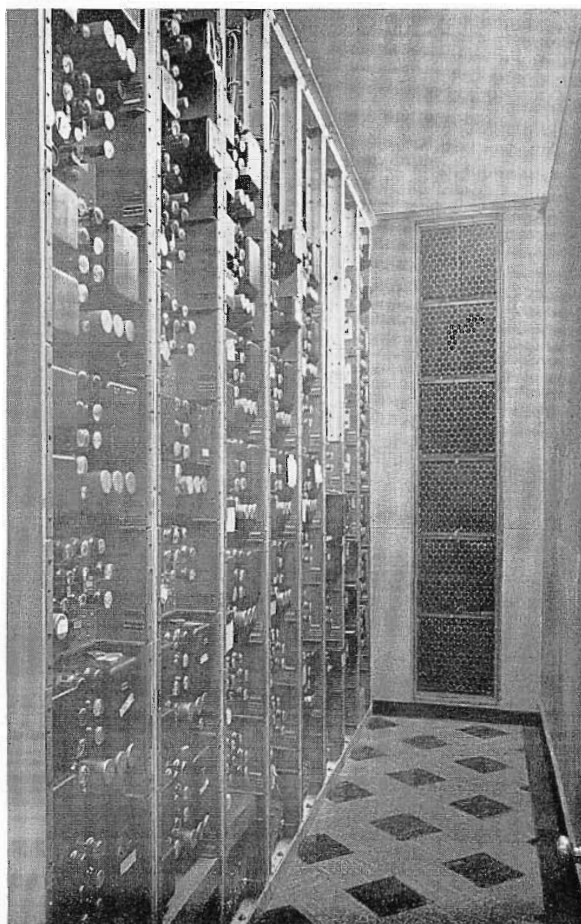

FIG. 26. Central power supply room.



FIG. 27. Station uses an RCA 6-bay superturnstile that radiates an effective power of 100,000 watts.

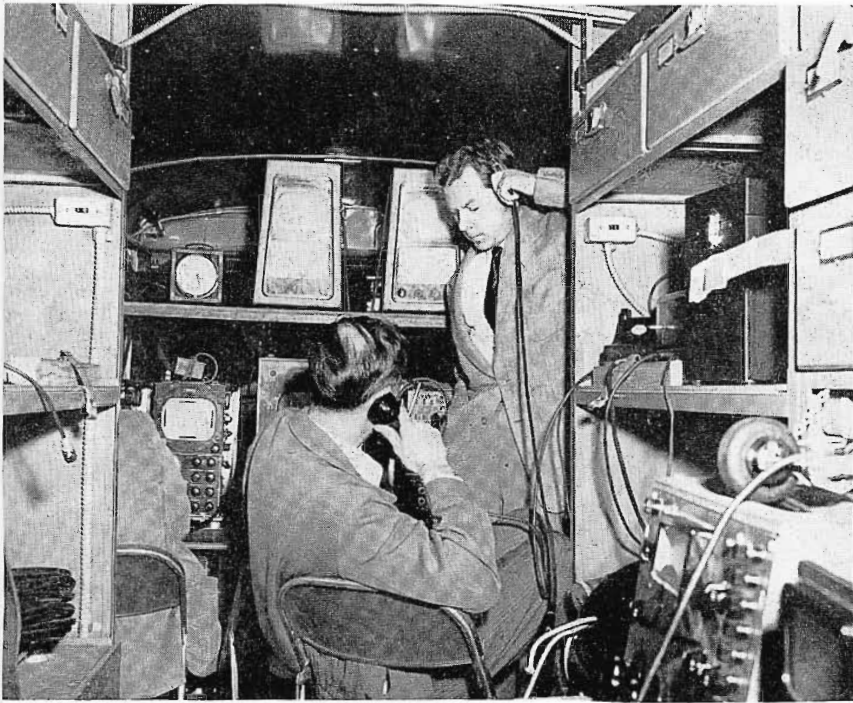

FIG. 28. Normal crew for remote pickup consists of 2 cameramen, 1 audio, 1 video control, director, and floor man.



FIG. 29. Mobile unit was used for pickup of more than 250 remotes during 1955.



FIG. 30. Inside view of KMTV mobile unit. (Note dolly-mounted equipment.)

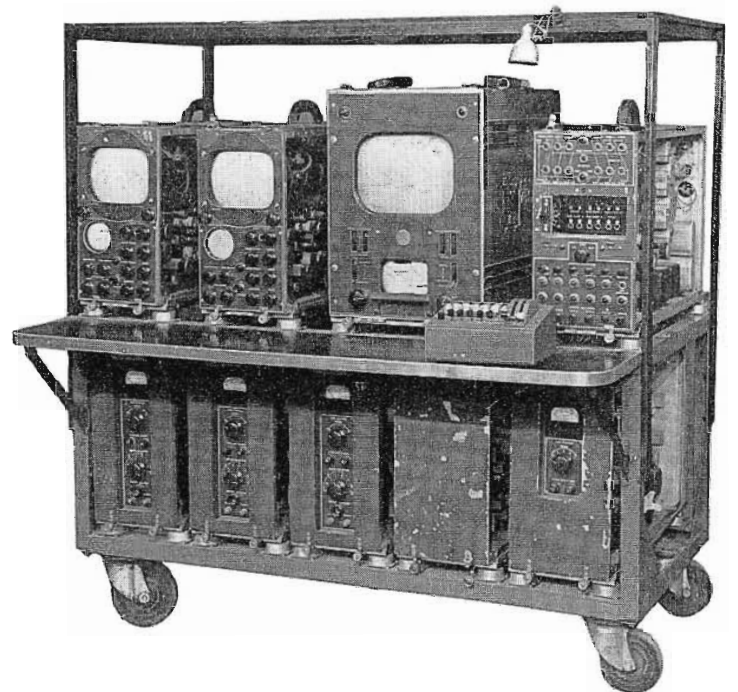

FIG. 31. Dolly-mounted TV equipment makes it possible to use field cameras in studios.

Field Equipment

A mobile TV unit for remote pickup has been constructed using a standard Dodge route van truck. This type of truck is only 17 inches off the ground at the rear door, and thus one can so easily get in and out of it. A platform was mounted on the roof for supporting two TV cameras. A ladder was bolted to the side for easy access to the roof-top platform.

Wooden cabinets were built into both sides of body for holding cameras, audio equipment, cables, tubes, miscellaneous parts and supplies. Also portable spots and floodlights.

Three RCA TK-11 field camera chains are used. Master monitor, field switcher, sync unit and power supplies are mounted on a 2-by-5-foot dolly. This can be rolled in and out of the truck as needed.

"The dolly-mounted field equipment makes it possible to use the same cameras for both remote and studio shows," reports Glen Klein, Engineering Supervisor. "It often makes remote pickups a lot simpler to handle. For example, when picking up a show on the fifth floor of a department store, it was not necessary to run cable five stories to the truck. The dolly unit was moved to the fifth floor for the duration of the show while the truck returned to the station.

"Common carrier service is usually employed for field pickups to link with the (studio) transmitter. In places frequently used for remotes, permanent cables have been installed so that it's merely a matter of plugging-in."

The normal crew for remotes consists of four technicians plus the director and floor man. Technicians divide as follows: 2 camera operators, 1 audio operator, 1 video control man.

More than 250 remotes were handled during the past year. During the summer the station averaged ten remotes weekly. Among these are regular ball games, stock car races, playground activities and downtown activities. The mobile truck has traveled as far as Abilene, Kansas, and Denver, Colorado.

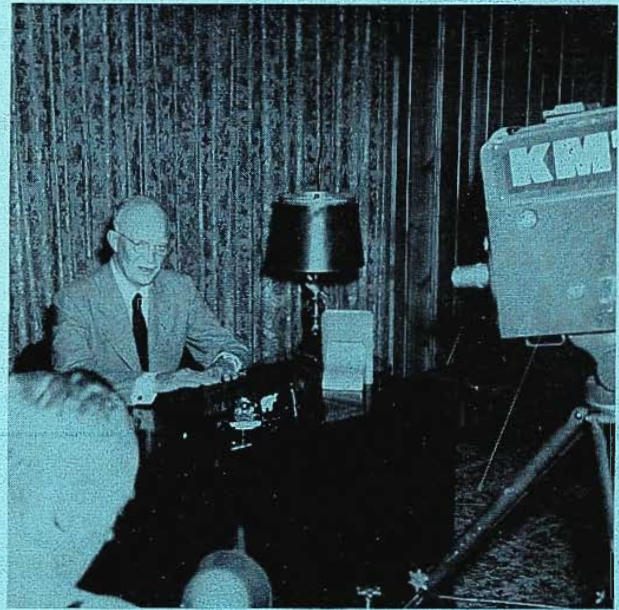

FIG. 32. Notable remote for station was pick up of President Eisenhower at Abilene, Kansas for nation-wide telecast over network.

KMTV Remotes

The station has a record of doing over 250 remote pickups for telecasting during 1955. Notable ones include "Person to Person" for Ed Murrow interviewing General LeMay, who heads the Strategic Air Command, with headquarters at Omaha. This required the use of five remote cameras and two remote locations: One at the General's home, the other at the air base headquarters.

Other pickups for well known programs were made for "Wide, Wide World." KMTV picked up the Omaha segment entitled, "Portrait of an American Winter." The KMTV cameras, one atop a 60-foot boom, showed the nation how winter affects the "Live Stock Center of the World."

FIG. 33. Another important pick up for a national network was in 1952 when the Missouri River went on its well-remembered rampage.

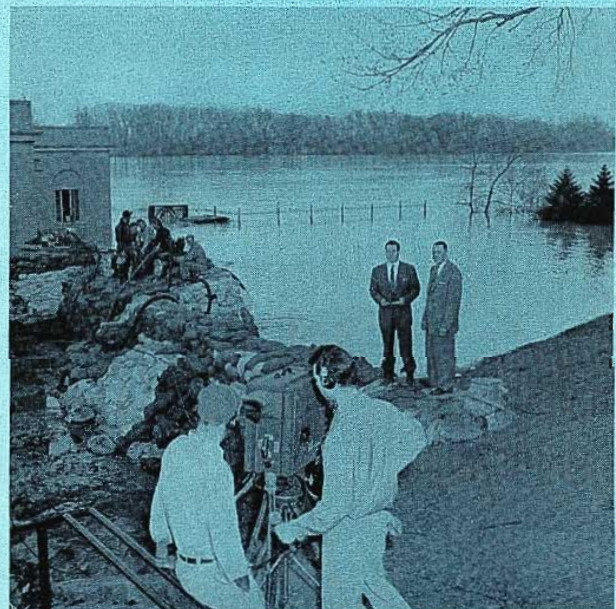

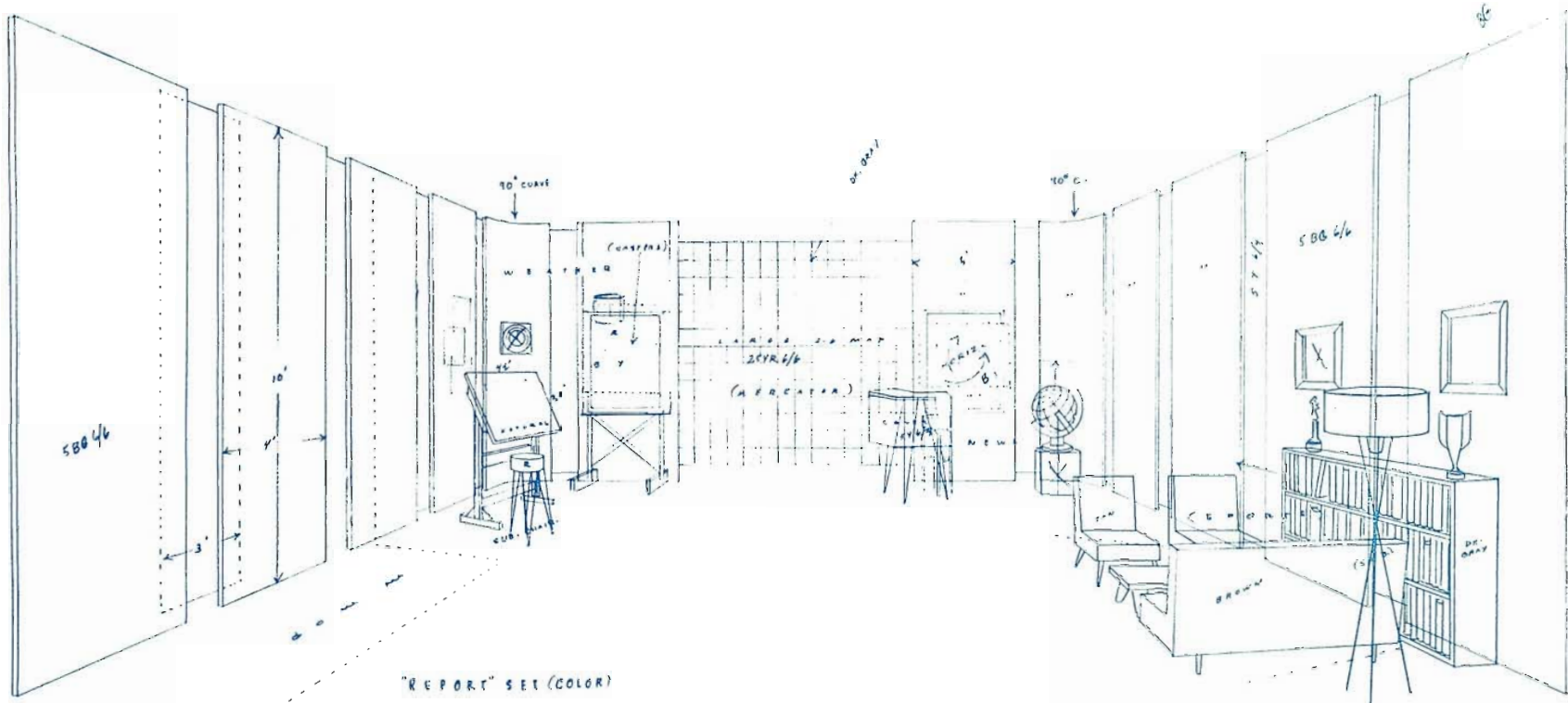

FIG. 34. Diagram of new weather-news-sports set designed to give best results for both monochrome and color.



FIG. 35. News segment of new color set.



FIG. 36. Weather segment of new color set.



FIG. 37. Owen Saddler, Executive Vice-President and General Manager.



FIG. 38. R. J. Schroeder, Chief Engineer.

Personnel

Executive Vice-President and General Manager: Owen Saddler

Chief Engineer: R. J. Schroeder

General Sales Manager: Arden Swisher

Program Director: Glenn Harris

Technical Staff:

Asst. Chief Engineer: Wally Schwentser

Engineering Supervisor: Glen Klein

In addition, a staff of 25 engineers

Promotion Manager: Amos Eastridge

Art Director: Bill Fries

Production Manager: Lew Jeffrey

The KMTV Engineering Department consists of 27 men under the direction of the chief engineer. The total station staff numbers 110.

Typical Color Preparation for the Future

Although the daily weather, news and sports programs are now done in black and white, it is only a matter of time until they are converted to color. The way KMTV is planning things, the switch could be made overnight. The combination weather-news-sports set has been completely redone, prepared for full color operation. The colors chosen are suitable for black and white also. This same philosophy is being applied to all sets. Any changes being made are done with an eye to color (Fig. 34).

Color Circulation

How many color receivers in this area? That's not the question of importance now. At this time the emphasis should be upon the medium itself. It's as simple as this: "You can't circulate a newspaper until you have a newspaper to circulate. We've got to have faith in our medium.

"In the day when color is common, the average viewer—as he turns the knob—will not be concerned with who had it first—but with who puts on the best shows. We believe that we will be among the best in the business because we had been in early and had gotten experience."

KMTV is carrying the torch for color so that its audience may be among the first to view this marvel, and its customers may be among the first to make effective use of this newest, and probably the most effective, tool of advertising.

color TV timetable

Admittedly there are different opinions on this subject in the industry, however KMTV management is sure that color will be good business for stations beginning by late 1956. Reasoning from this premise, meant that color equipment should be obtained at least a year in advance—for two reasons: First, in order to get experience; second, to avoid the equipment rush.

Without doubt, time and effort are required to integrate color operations into the normal routine of a station. It's something new and different. People have to be taught: Engineers, artists, production and program people. Also agencies, sponsors and management need to know the new medium before it can be effectively used. All this takes time. The best plan is to get this under the belt before time runs out on the color timetable.

By Fall of 1956, KMTV will have a working force expertly familiar with color. Live programming experience will total almost 1000 shows. Film programming will also run an impressive total score. Color commercials and demonstrations will be old hat to the staff.

When advertisers clamor for color, KMTV will be ready. There'll be no last minute rush for equipment—equipment that probably cannot be obtained because everyone wants it then. Station management says it this way: "We will have a working system. We will be able to produce. Our station will be an authority." This is undoubtedly an enviable position



FIG. 1. (top). Leading the way up the old Broad Street trail were 64 Tall Texans from the Avalon String Band. They marched towards the reviewing stand to the strain of "Deep in the Heart of Texas".

FIG. 2 (center). Shooting for its 13th championship in 34 parading years, the Ferko String Band approached the mobile unit at South Broad Street in Philadelphia.



FIG. 3 (bottom). Marching eight abreast, the 64 musicians of the Ferko String Band showed off their brilliant Birds of Paradise costumes.

WCAU-TV MUMMERS

Engineering and production personnel of WCAU-TV, the CBS television outlet in Philadelphia, braved the biting cold on Monday, January 2, to air for 3¼ hours the first color telecast of the Philadelphia Mummers' Parade. Two color mobile trucks, leased from RCA, were used to cover the dazzling extravaganza that has become Philadelphia's own unique New Year's festival. This year over 10,000 "Mummers", members of neighborhood clubs dressed in fancy costumes, paraded up Broad St.—carrying on a custom that dates back nearly a hundred years.

The origin of the New Year "Shooters", as the Mummers were known until well past the turn of the century, can be traced to folk festivals as far back as Roman times.

*Photos on this page taken by
Don Pierce, TV Camera Engineering,
Broadcast and TV Equipment Department*



FIG. 4. On the day before the parade this color mobile truck was in place at the South Broad Street location. In front of the truck, one of the TK-41 live color cameras is mounted on the specially designed wooden platform. Good maneuverability was obtained by the use of these fork-lift trucks for the color cameras.

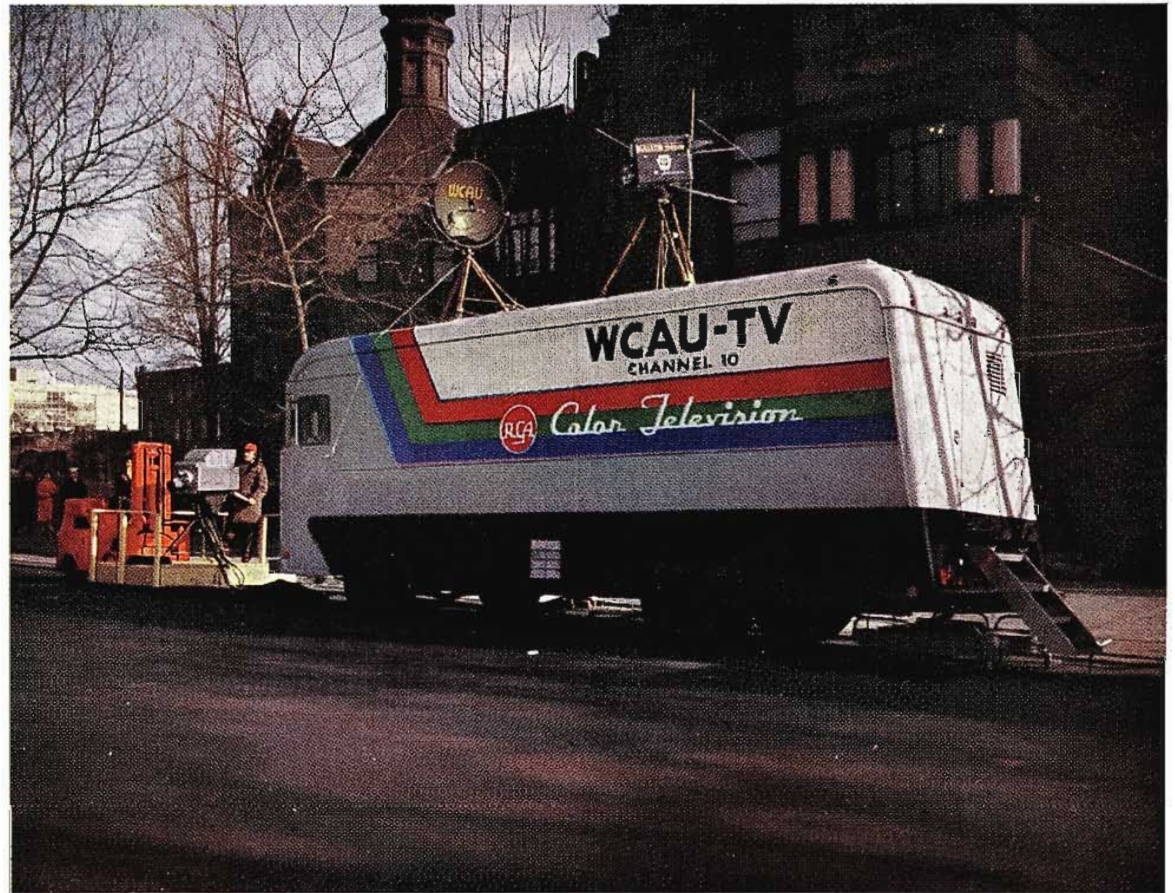

COVERS PHILADELPHIA PARADE IN COLOR

Thus, the parade represents a welcoming of the New Year which has evolved into its present form over a considerable period of time. Over 200,000 Philadelphians and out-of-towners lined the 4-mile parade route along Broad Street to watch the prancing, brilliantly clad marchers strut and clown to the music of 20 string bands.

Four RCA TK-41 color cameras, two at each truck location, picked up the thirty marching units competing for \$52,000 in prizes put up by the city. One of the mobile units, see Fig. 7, was located at City Hall, near the reviewing stand; the other truck was placed near the start of the parade route at Porter Street in South Philadelphia. Camera locations gave the TV viewer a variety of angles and shots simply impossible to see from a fixed position. Close-up shots disclosed details of the finery that sidewalk spectators were unable to view.

Telecast Carefully Planned

As early as December 10 preparations were being made to insure the success of the telecast. At that time, WCAU engineers began a series of outdoor color tests under varied conditions to determine what could be done to cope with the problem of changing lights and shadows.

By waiting long hours for test shots of various cloud conditions, WCAU was able to anticipate the changing lights and shadows during airtime. Camera locations along the parade route were checked for additional information on light conditions at the times of day that would correspond to actual parade time.

Pre-Parade Technical Preparations

To assure the success of the telecast, WCAU engineers began work on the Friday preceding the parade and worked through the holiday weekend. One of the

RCA color mobile units was located near the beginning of the parade route in South Philadelphia and the other mobile unit was at the City Hall location. On Friday afternoon power connections from an adjoining building to the first unit were made as shown in Fig. 5. A checkout of the equipment disclosed that it was operating satisfactorily. Engineering personnel from RCA, acting in an advisory capacity, assisted the WCAU crews during the pre-parade preparatory phases and stood by during the actual parade.

Gaps in a parade always present a problem—no live action in front of the cameras. To cope with this, the TK-41 cameras were spaced a block apart with the mobile unit in between.

Color Equipment

Each mobile unit had two TK-41 live color camera chains, two TM-10B 15-inch



FIG. 5. On this side of the color mobile unit, the receptacle at the right contains sockets for connecting audio, video, telco lines and microwave facilities. At the left is the power-line receptacle.

self-contained color picture monitors, three TM-6C master monitors and associated test equipment. Interior views of one unit are shown in Figs. 11 and 13. The camera chains are so designed that the cameraman can concentrate on picture content, since only two handle controls are required during on-air operations. The camera control operator oversees signal processing for best picture quality and monitors the entire operation. The master monitor provides both picture and waveform monitoring of signals at any stage of transmission from the camera to the output of the colorplexer.

Video switching functions between the color cameras at each mobile unit location were effected by a TS-11A switcher. At the TS-11A switcher, signals from each camera may be superimposed, faded, lap dissolved or fed directly to the output line. Composite

video signals from each mobile unit were fed through twin-feed telephone company lines to WCAU master control at which point the program was microwaved to the transmitter location.

Audio facilities included a BC-4 console located next to one of the master monitors. Music from the string bands was picked up by a microphone on top of the mobile unit. Two announcers using hand-held microphones alternated in carrying the parade commentary at the South Broad Street location. Commentary and music were then mixed and fed to master control through telephone company facilities.

All equipment was thoroughly checked out and put into operation on Saturday. Camera cables were strung in the trees lining Broad street in order to eliminate any interference from the throngs of people watching the parade. Personnel from WCAU brushed up on operating techniques with the color equipment, experiencing no difficulty with the color gear, even though it was a new experience for them.

Camera Platforms

A unique innovation introduced by WCAU was the use of specially built 6 by 7 ft wooden platforms on fork-lift trucks which served as camera platforms. These were raised and lowered as different camera angles were called for. This device provided a high degree of flexibility in camera maneuvers to cope with the varying conditions at the parade.



FIG. 6. This string band has halted momentarily after having passed the mobile truck parked in the middle of the block. The thin silk costumes of the Mumpers provided little protection against the cold as compared to the well-dressed cameraman.

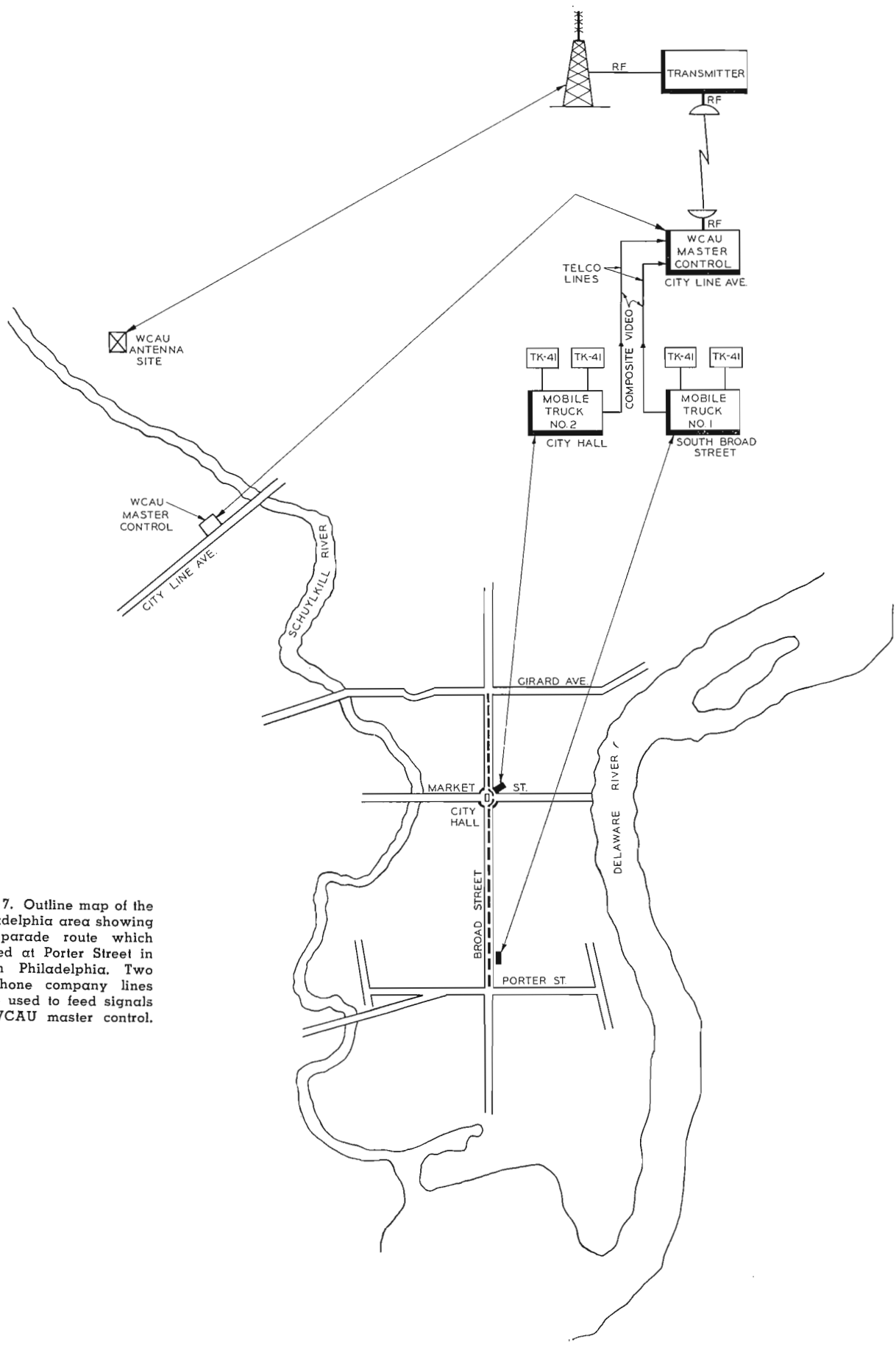

FIG. 7. Outline map of the Philadelphia area showing the parade route which started at Porter Street in South Philadelphia. Two telephone company lines were used to feed signals to WCAU master control.

FIG. 8. Some appreciation of the splendor of the Mummer's costuming can be gained by this view of one single cape divided into four sections.

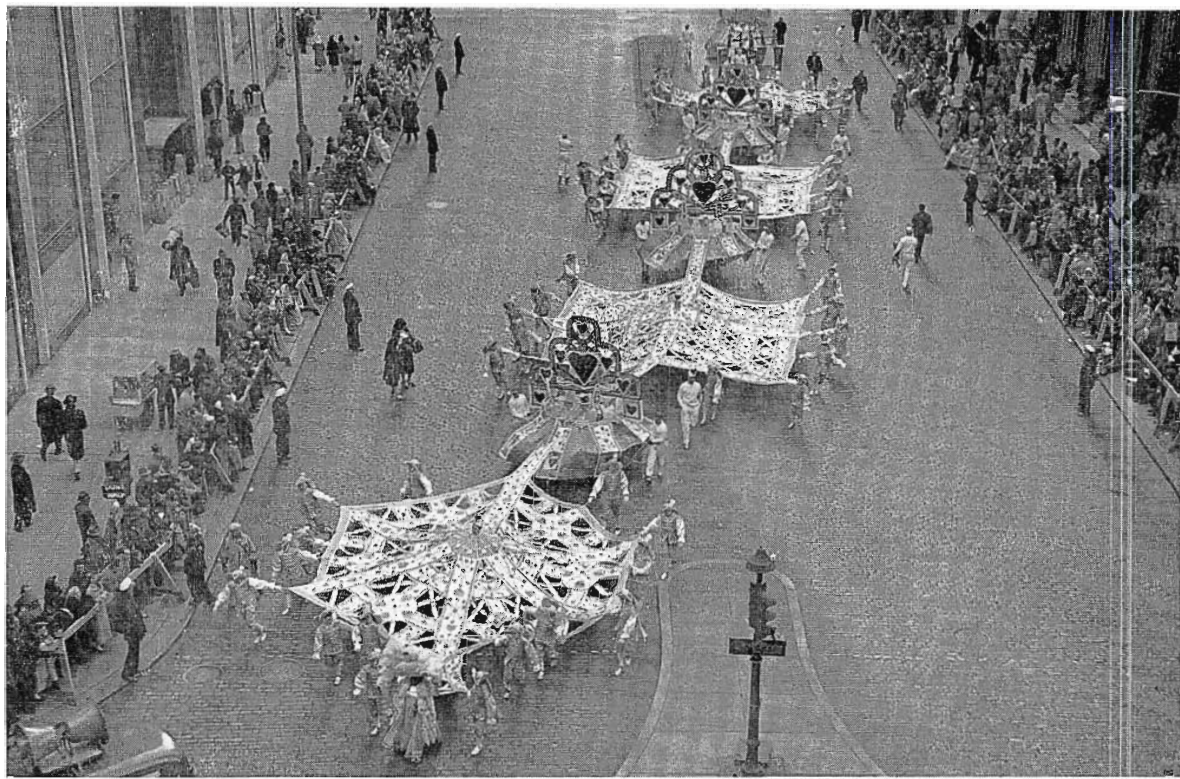

FIG. 9. This attractive young "lady" is one of many men dressed in female attire who were part of the parade before wartime.



FIG. 10. This young Indian brave has decided not to let another year go by before joining the passing parade. Many such father and son teams were to be seen in the parade.



Dress Rehearsal

New Year's Day—Sunday saw all of WCAU's operating crews on location again. Equipment was set up and check-out operations were again repeated. Engineers from RCA made their own final check of the color gear and then retired to the sidelines—standing by in case they should be needed. WCAU operating personnel continued familiarizing themselves with the mobile unit equipment.

After all these equipment tests and checkouts, an informal dress rehearsal was run. Camera elevations were determined and lighting angles re-evaluated. Audio and intercom checkouts as well as switching between cameras showed everything to be working smoothly. A "Round Robin" circuit, provided by the telephone company, was used for intercom between WCAU master control and both mobile units. Thus a three-party hookup was in effect at all times—each party able to hear and break in on the other two.

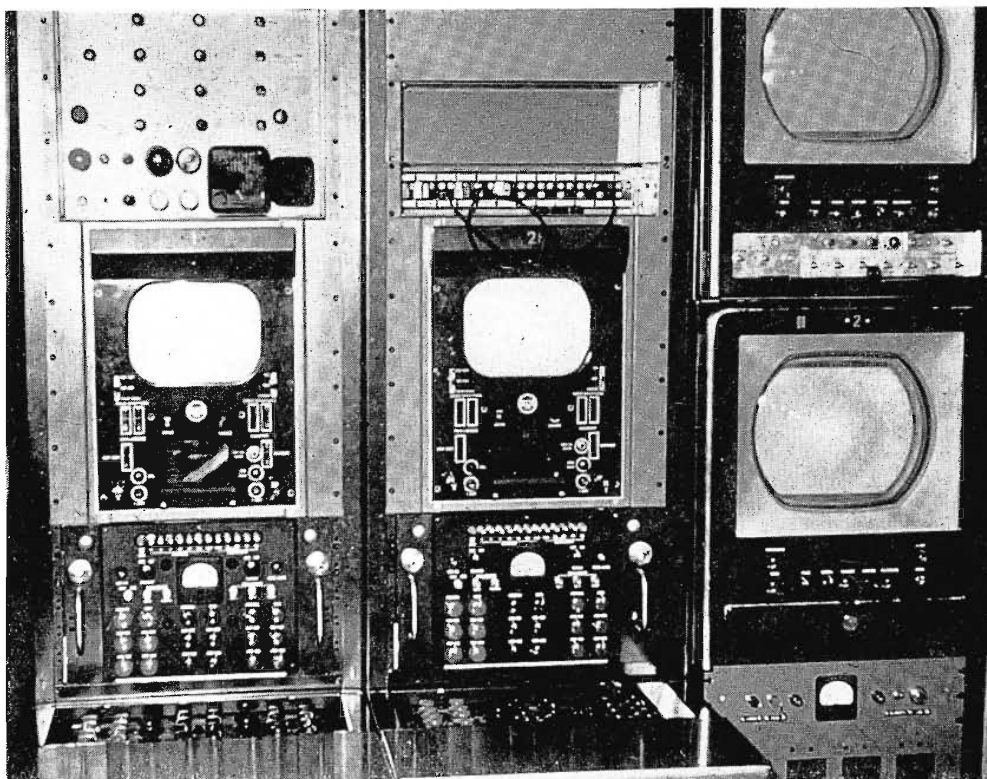

FIG. 11. Interior of the color mobile unit showing the two video channels. At the left are the two TM-6C master monitors with camera control panels immediately below them. At the right are two TM-10B color picture monitors.

FIG. 12. At City Hall a contingent of Mummers passes the second mobile unit which can be seen at the left of this picture.



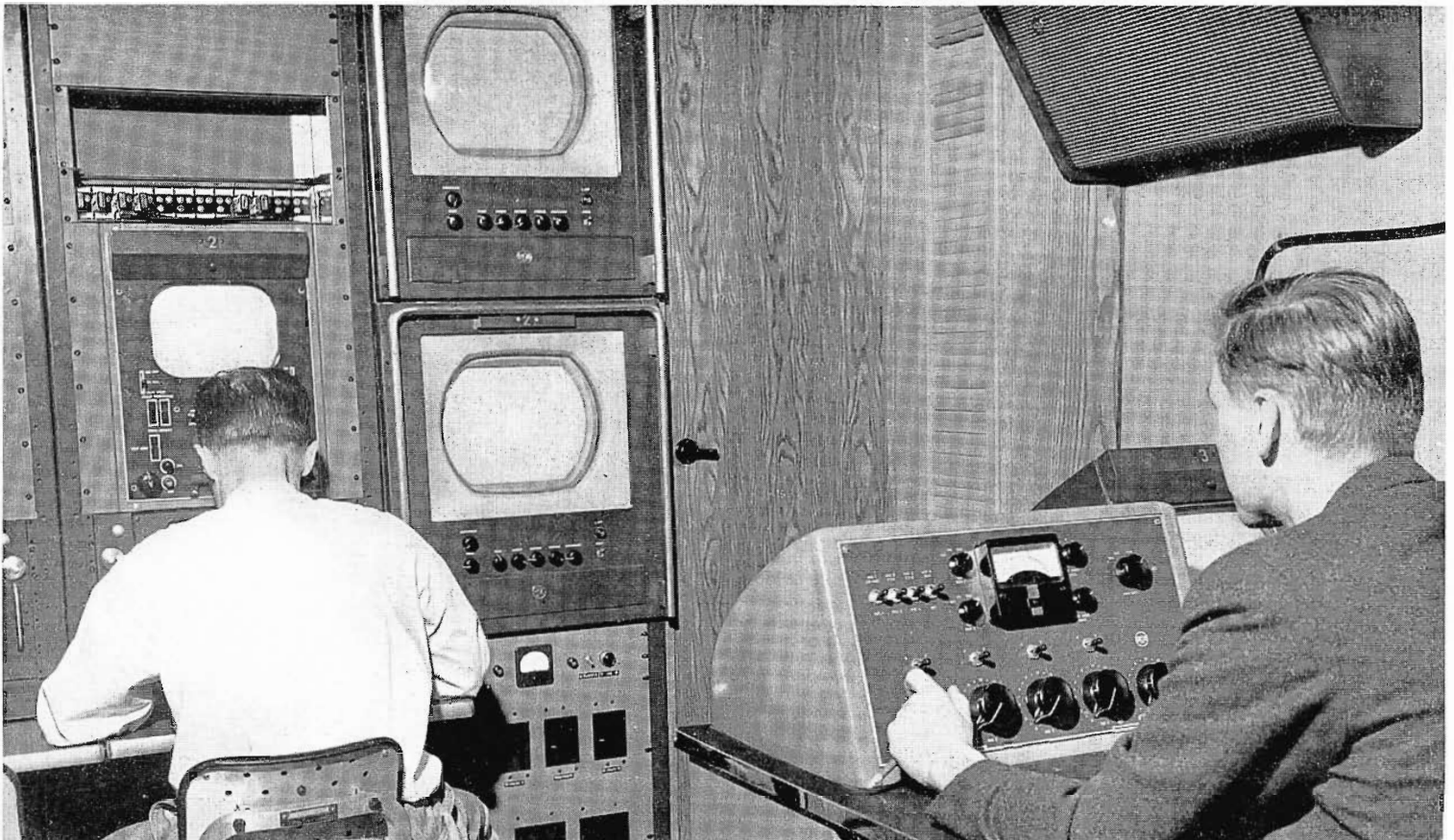

FIG. 13. Inside the color mobile unit at South Broad where the major part of the Mummers' Day Parade originated. From left to right are the TM-6C master monitors, the two TM-10B color picture monitors, a BC-4 audio console and another TM-6C master monitor.

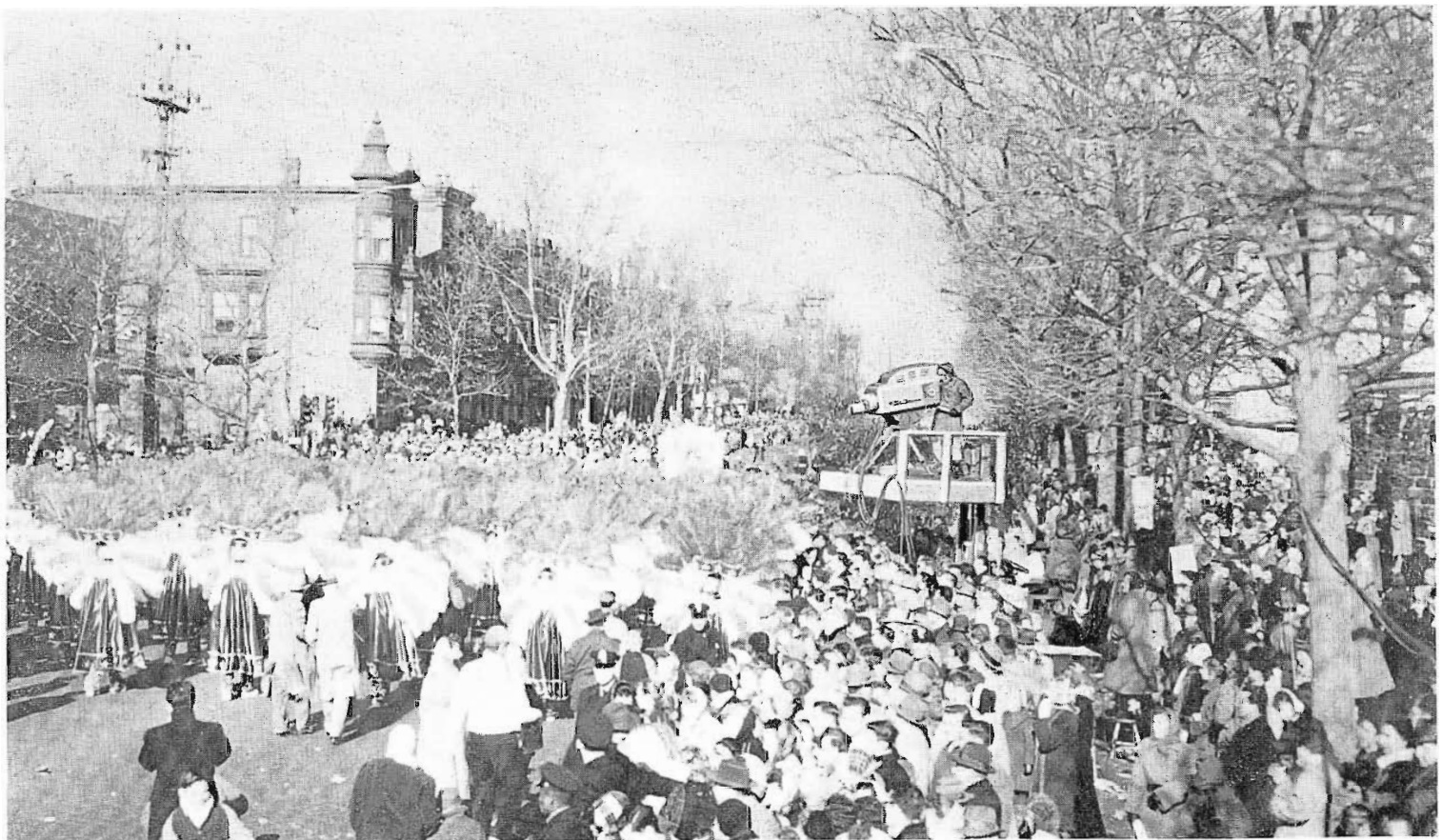

FIG. 14. As another string band goes "down-the-street", the TK-41 color camera picks up all the brilliance and color of the New Year's Festival. Good camera angles were obtained owing to the elevation afforded by the fork-lift truck.



FIG. 15. Sixty-four "Tall Texans" were the first of the many string bands to march past the first color mobile unit.

Color Balance

Both mobile units then fed signals, using twin-feed telephone company lines, to WCAU master control where color balance was made. Good color balance requires that each camera chain render the brightness, hue and saturation of color to the same degree. In the colorplexer, the red, green and blue signals provided by the color camera are processed to produce a signal conforming to FCC signal specifications.

At this point it should be remembered that the color bar-generator output is fed directly into a colorplexer to adjust for perfect multiplexing. In order to check out the entire system, including cameras at both remote locations, the WCAU engineers had colored silk strips mounted on wooden frames. These colored strips were intended to physically simulate the bar-generator output. With these colored strips picked up by the cameras at both color mobile unit locations, and one at master control for comparison purposes—good color balance was achieved.

On the Air

In the early hours of the morning on Monday—Mummers' Day—another rehearsal was held prior to air time. Owing to the freezing weather, filament power to the cameras was left on all night to keep the

cameras warm and reduce set-up time. All these rehearsals were to make the telecast the smooth operation that everyone had hoped for. The parade started promptly at 8:30 a.m. despite the cold and seeming lack of order, with the Mummers "on camera" but not on the air.

At 10:30 a.m. station WCAU-TV went on the air for the first time with live color to catch this dazzling spectacle in all its variegated hues and sparkling gaiety. The sun was intermittently hidden by an overcast sky, but when it came out the feathered costumes of the marchers were beautifully back-lighted.

The parade moved along well at its starting point, but at City Hall, see Fig. 12. where the other mobile unit was located, marchers began to bunch up. In addition, the deep shadows cast by the large buildings in the downtown area of the city were quite a problem. Consequently, with the low buildings on South Broad presenting less of a shadow problem—most of the parade was picked up from this location.

Another consideration favoring the South Broad Street location was the fact that WCAU was going off the air at 1:45 p.m. To pick up the more colorful string bands towards the end of the parade, WCAU had

to stay with the mobile truck at the start of the line of march.

At 1:45 p.m. the parade went off the air; WCAU having done a noteworthy job on this their first live color telecast. The color mobile unit demonstrated the ruggedness and reliability of the color gear, as well as the high-resolution picture capabilities of the equipment.

The problem of maintaining sharp black-and-white contrast while achieving faithful reproduction of color shadings was successfully solved according to comments from TV viewers.

One of the things that impressed us was the way WCAU operating personnel handled this remote color telecast, working as they did with unfamiliar equipment—they ran the entire operation and produced a wonderful show. Preparations and numerous equipment checkouts for this parade may seem to have been repetitious, but it paid off with an impressive production in color and monochrome.

Because this was their first experience with live color cameras, WCAU put in a lot of hard work. Future remotes, should WCAU acquire their own TK-41 cameras, would become almost as simple as black-and-white pickups.



FIG. 1. External view of RCA Color Television Mobile Unit—designed to house two live color camera chains and associated equipment.

A MOBILE UNIT FOR COLOR TELEVISION BROADCASTING AND CLOSED-CIRCUIT APPLICATIONS

The versatility of Television Mobile Units and their advantages in affording extra revenue by opening new avenues of programming are well recognized by broadcasters. Now a similar unit is available for color television. This unit embodies complete facilities for remote color pickup, whether for on-air or for closed-circuit application. It may also be used at the studio location as a temporary color facility, providing a quick means of getting on the air with live color.

The RCA Color Mobile Unit is designed to adequately accommodate two color camera chains with a full complement of equipment, and still provide room for comfortable operation. The equipment is housed in a 28-foot truck complete with heating and air-conditioning.

by **HENRY H. KLERX**
RCA Broadcast Video Equipment
Sales Department

FIG. 2. Control room section of truck—showing camera controls (left) and audio control (right).



Equipment

Figure 5 shows the location of equipment and storage sections within the truck. This illustration also shows how the truck has been divided into two sections. The front section is the operating area. The rear section is a storage area which also houses many of the components required for operation of the two color cameras. The mobile unit with full complement of equipment includes two TK-41 live color camera chains, TS-11A switcher, BC-4A audio console, color sync and test equipment, power supplies, and audio, video, camera and power cables. Provision has also been made to include microwave facilities.

Control Room

Figure 4 shows a view of the operating area looking from the front of the truck

FIG. 3. RCA Color Television Mobile Unit on location at Garden State Park before track time.

toward the rear. The first row of equipment (right foreground) is the audio console and switcher. The seating arrangement here is such that either one or two men can operate at this position. This seat serves for equipment operation and, with the back of the seat moved towards the rear of the truck, it serves as an auxiliary seat for transporting passengers. The second row of equipment (towards back of truck, Figs. 4 and 7) which consists of three racks is, looking from left to right, camera No. 1 control, camera No. 2 control, and color monitoring facilities. A centralized power control panel is mounted directly beneath the monitoring facilities and is within easy reach of the camera operator.

Signal Paths

The processing of the video and audio signals entering the mobile unit is accomplished in the following manner: The red, blue and green video signals received from each of the color cameras are fed to a video entrance panel. The signal at this point proceeds directly to the respective camera control panels. The necessary shading, pedestal, gain and image orthicon setup adjustments for each of the red, blue and green channels are performed at this point. The corrected video signal then leaves the processing amplifier which is the unit located directly beneath the master monitor in Figs. 4 and 7 and is fed to the colorplexer which matrixes the red, blue and green signals to provide the Y, I and Q signals required for color transmission.

The output of each colorplexer (one required for each camera chain) is fed through the video patch panel to the TS-11A switcher. At this point in the system,



the signals from each camera may be faded, lap dissolved, superimposed, or switched directly to the output line. Sync is added at this point, which completes the makeup of the NTSC color signal.

The composite signal is fed to the video patch panel and then to the video output jack located on the entrance panel. A sec-

ond output of the TS-11A switcher is also fed to the video patch panel and is available for feeding the microwave control. Facilities have also been provided for receiving additional external monochrome or color signals which may also be controlled by the TS-11A switcher. This permits considerable flexibility when the mobile facilities are used to handle only part of an entire show.

Operation

A crew of four men is normally needed to operate the equipment within the truck. Two video operators normally operate the two color camera chains. Each operator has a color monitor and master monitor to assist him in properly setting up the camera chain. The color monitors also double as preview monitors for the director. The director and audio operator are located to the rear of the camera operators, affording them full view of the monitoring facilities.

Power

Figure 9 shows the inside of the mobile truck looking from the rear door towards

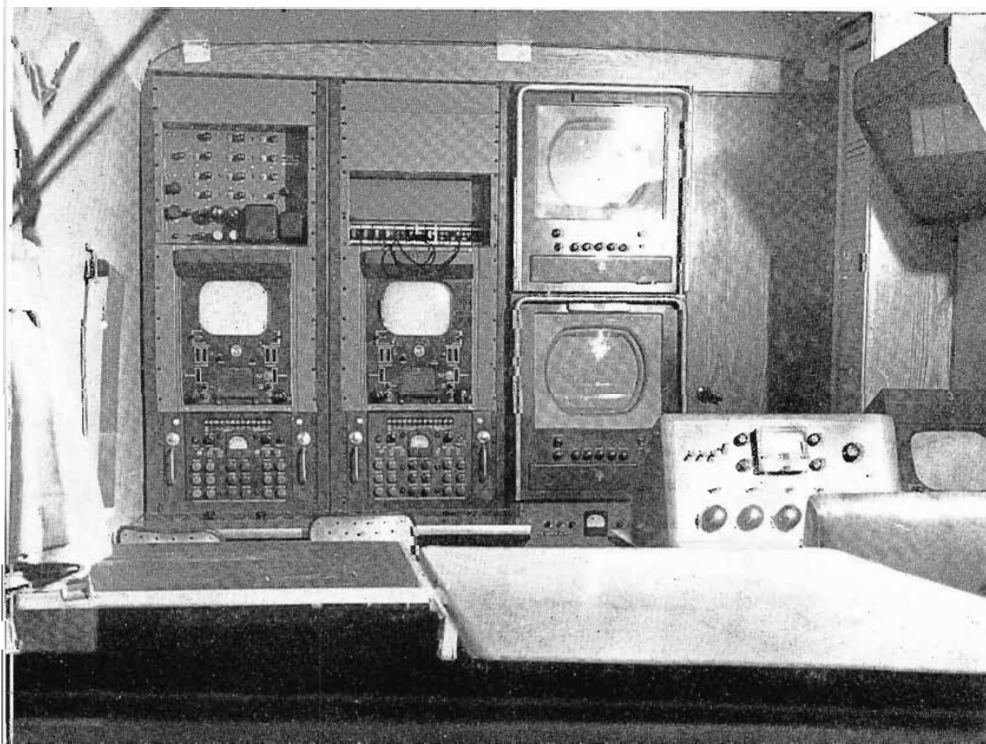

FIG. 4. Full view of control room showing director's table in extreme front of truck.

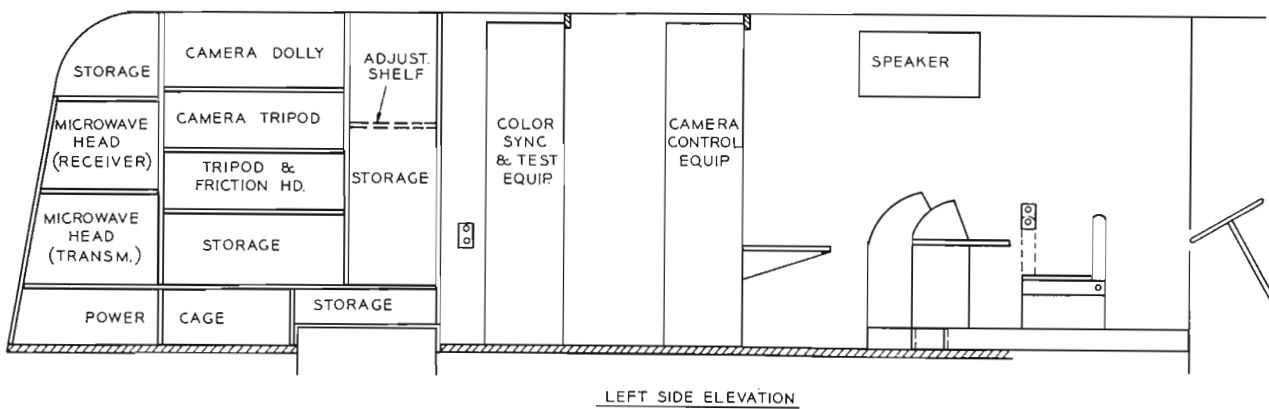
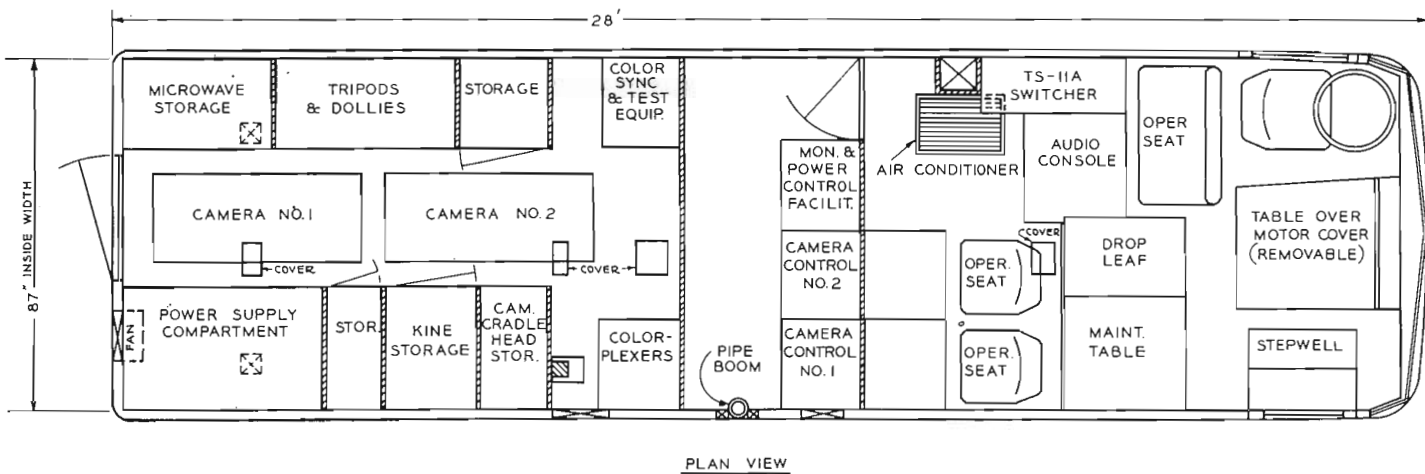
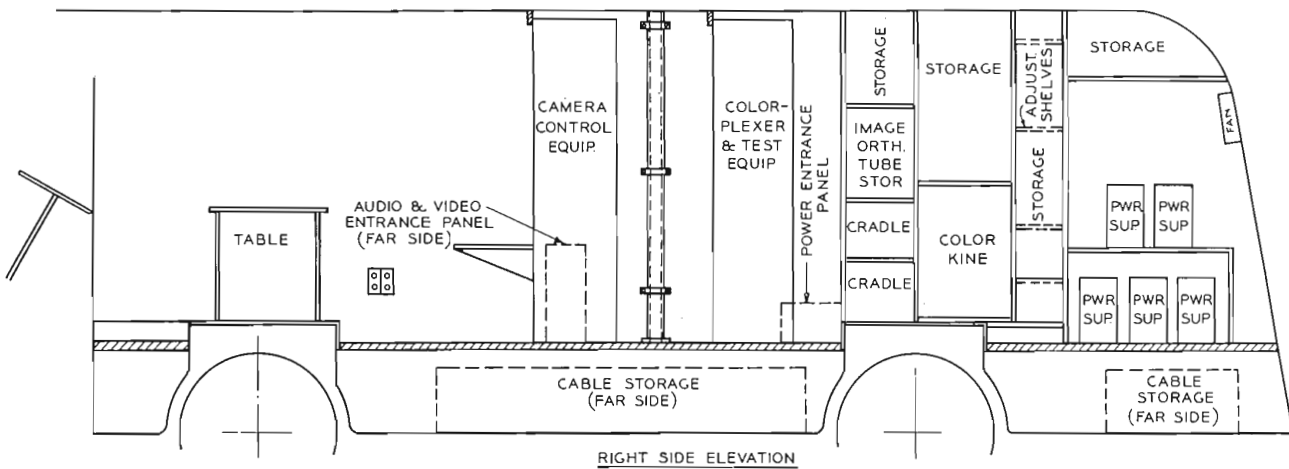

FIG. 5. Equipment plan views.

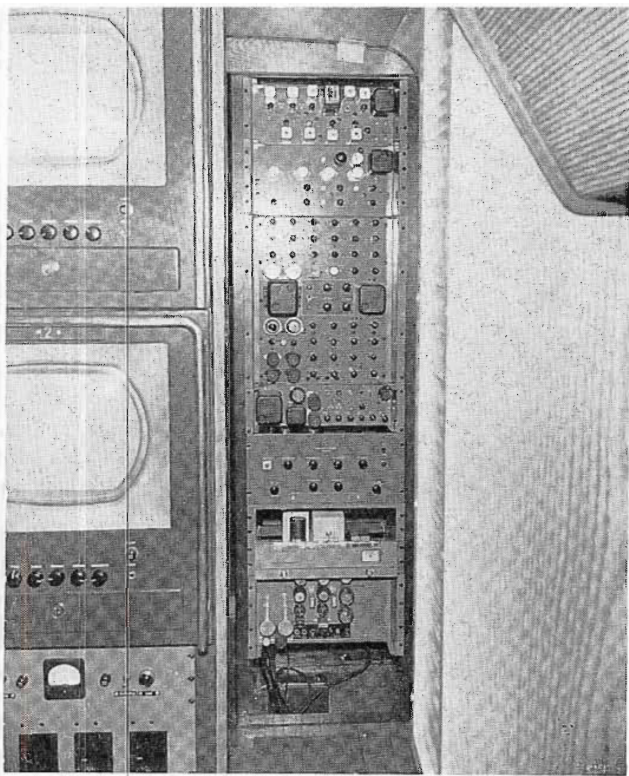

FIG. 6. (Center) Rack containing color sync generating equipment—located beyond rear entrance door to control room.

with the camera control racks. This panel provides connections for the two camera inputs, three microphones, and one remote audio input, one video input, microwave control output, video and audio outputs.

The power entrance panel located more to the rear of the truck contains four ac output receptacles and main input power connection. The external source of power required to operate the color mobile unit is single phase, 220 volts, 90 amperes.

Storage of the camera and power cable is located externally in the skirt line of the truck. There are three compartments provided, which are capable of carrying approximately 1,500 feet of camera cable and 100 feet of four conductor #4 power cable. Each color camera requires three interconnecting cables, therefore, the 1,500 feet of camera cable mentioned above actually serves the requirement of two cameras. Past experience has indicated that cable runs up to 350 feet in length have little

effect on the over-all performance of the TK-41 camera.

Provision for Microwave

To facilitate the setup and use of microwave, a 6 by 15-foot area of the roof has been reinforced with steel plating. Provision has also been made for storage of parabolic reflectors. A 3-inch pipe has been installed on the curb or passenger's side of the truck. This pipe extends from the floor to about 3 inches above the roof. There is a smaller pipe which fits inside the 3-inch pipe which can be extended to a maximum of 5 feet above the roof. In locations where it is necessary to run the camera and power cables overhead, this pipe can be used as a convenient anchorage. It may also be used as a gin pole for lifting equipment to the roof of the truck.

Truck Specifications

The truck is 28 feet over-all in length by 87 inches in width. Interior height is 82

the front. Field type power supplies are shown at the extreme right hand rear. A total of five such supplies are required. Behind the grill along the floor on the left side are located a 15-kva isolation transformer and a powerstat line corrector. The powerstat line corrector is remotely controlled from the power distribution panel located in the operating section of the truck. The center aisle is used to store the two color cameras.

Test Equipment

Not illustrated in the photograph, but depicted in Fig. 5 are two racks also located in the rear portion of the truck. These racks house the colorplexers, color sync equipment and test equipment. The test equipment includes: a bar generator for alignment of colorplexers and color monitors; calibration pulse generator permitting calibration of all signal displaying devices against a common source; linearity checker; color signal analyzer; and oscilloscope.

Wiring and Terminations

Interconnection of all equipment located throughout the truck is accomplished by wiring through ducts installed underneath the floor. All incoming and outgoing lines terminate at panels located on the curb side of the truck. There are two such panels. One panel is located directly in line

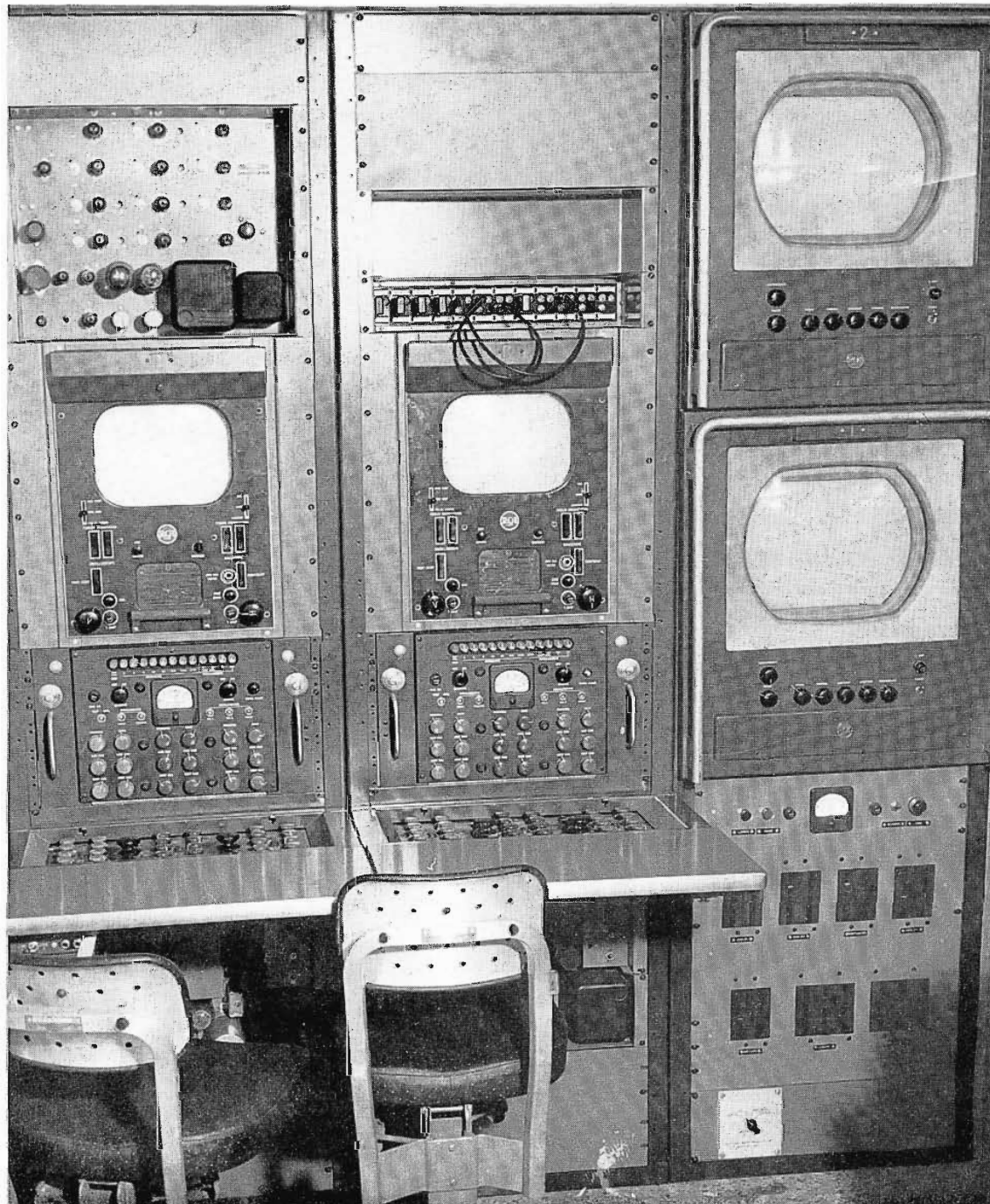

FIG. 7. Close-up showing full detail of camera control equipment and centralized power control panel (lower right).

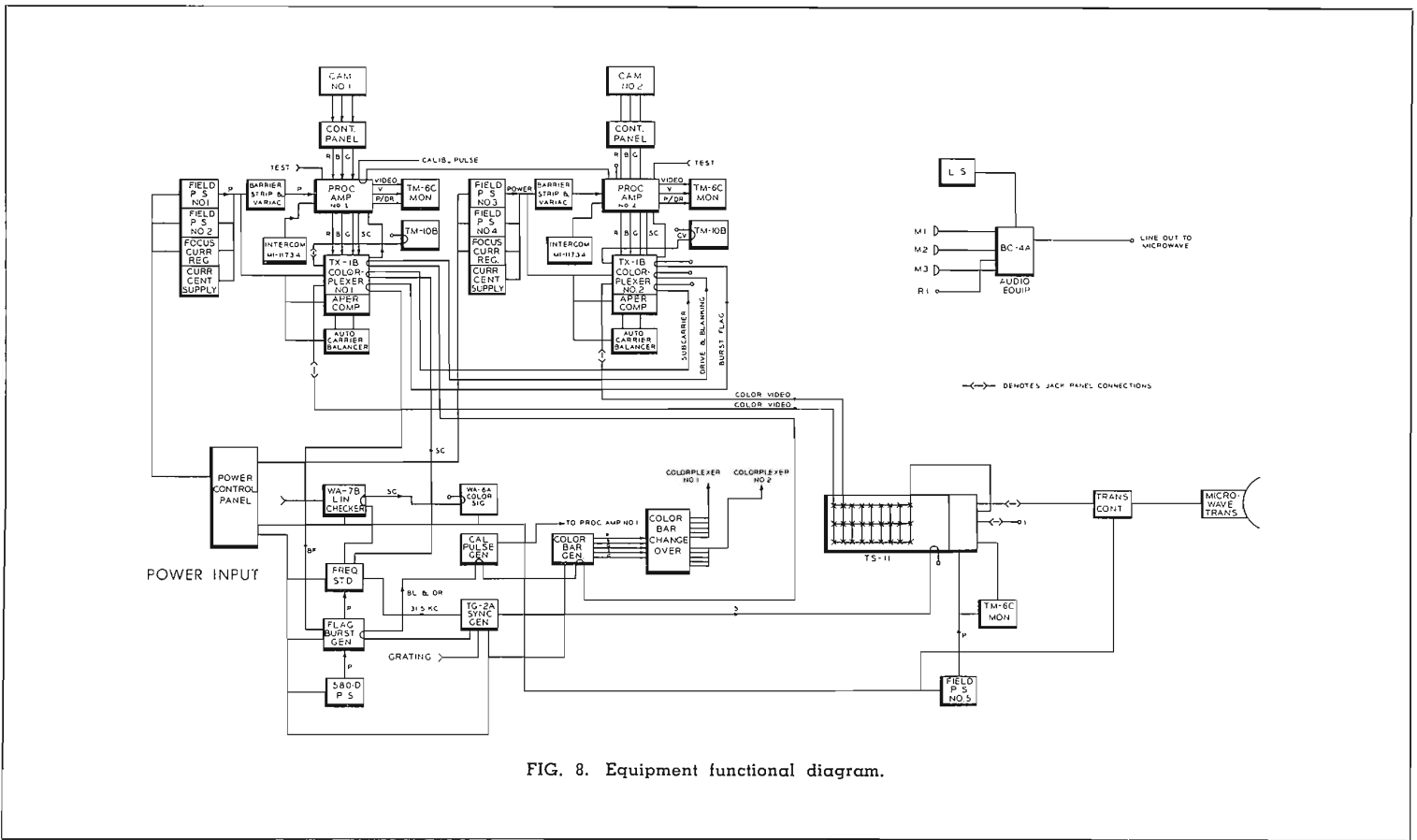

FIG. 8. Equipment functional diagram.

FIG. 9. View looking through rear door of truck showing general storage area.

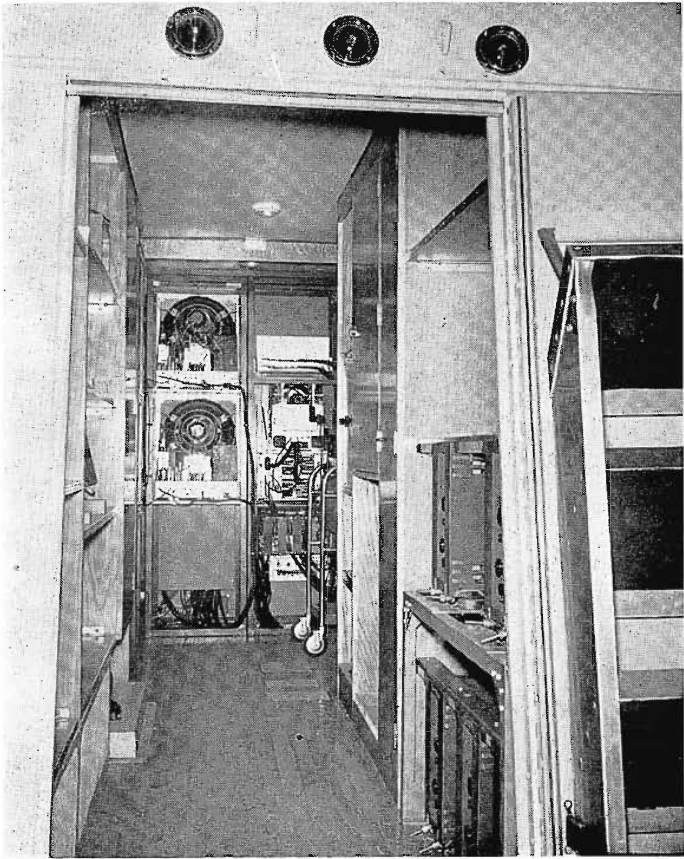
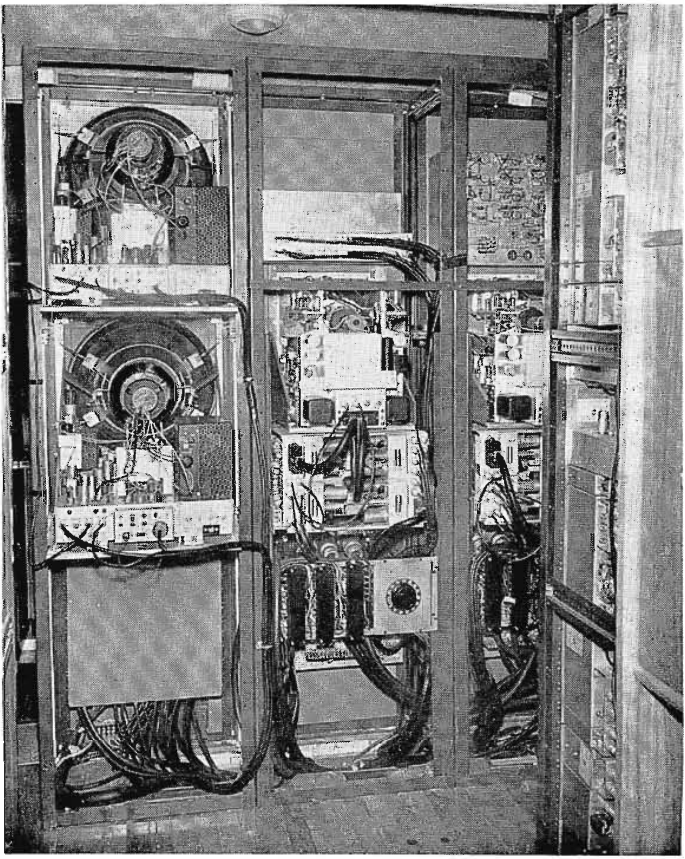

FIG. 10. Rear of camera control and monitoring racks. At right foreground, colorplexers and color test equipment.



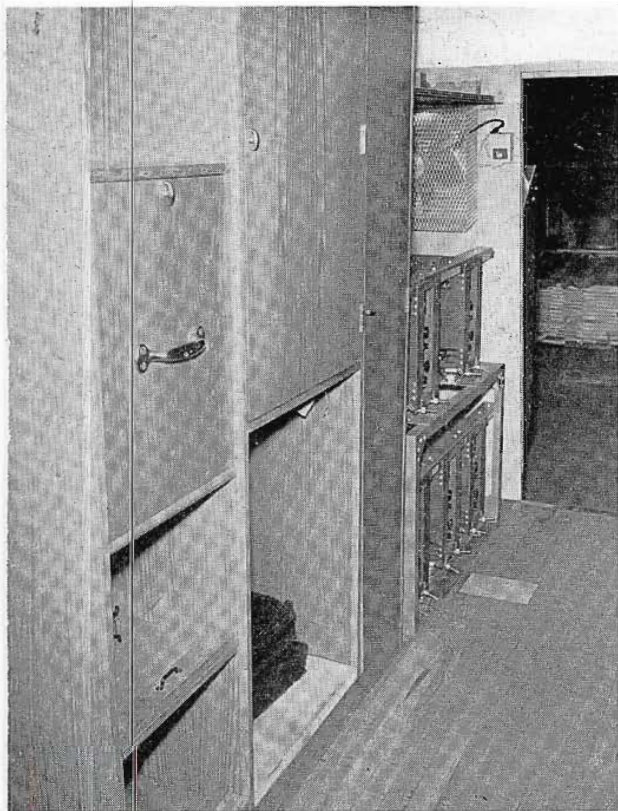

FIG. 11. Storage cabinet area and power supply compartment on right side of truck. Pull-out drawer with large handle provides protective space for image orthicon tubes.

inches from the floor to ceiling. Of this space 22 feet are allotted to electronic equipment and auxiliary items. The gross vehicle rating is 24,000 pounds. This includes a large safety factor. Some of the safety measures that have been incorporated in the truck are air brakes, power steering, tinted glass, and a hydraulically positioned driver's seat. These features also serve to simplify the operation of the truck and reduce driver's fatigue.

The power required to propel the truck is provided by a 170 hp V-8 engine driving a five-speed transmission. The engine is mounted on a pull-out slide assembly which permits ready access for major repairs. The weight distribution of the equipment installed in the truck was calculated in order to insure proper axle loading and riding comfort. A two-ton air conditioner is mounted underneath the chassis and is readily accessible through a side compartment for ease of maintenance and servicing. This air conditioner also contains a heating element which is used in cold weather to heat the operating section of the truck.

Fold-out steps have been provided on the rear door of the truck to gain access to the roof. Ladder hooks have been provided on both the rear and curb side of the roof to secure a step ladder if desired.



FIG. 12. Curb-side of truck showing power and audio/video terminal receptacles—power input on left—audio/video on right.

Detachable aluminum walk-up steps are used to gain entrance to the rear of the truck and are stored on the rear door when not in use.

The RCA Color Mobile Unit has proved itself as a valuable facility for Color Television Broadcast pickup. The complement of equipment consists of items that have gained the confidence of TV Broadcasters

throughout the country. Station personnel quickly become proficient with its operation because of its simple straightforward layouts and its familiar "feel" that characterizes RCA equipment in general.

A Color Mobile Unit such as this can be supplied for broadcast or closed circuit applications. Custom-designed units can be built to satisfy any user's requirements.

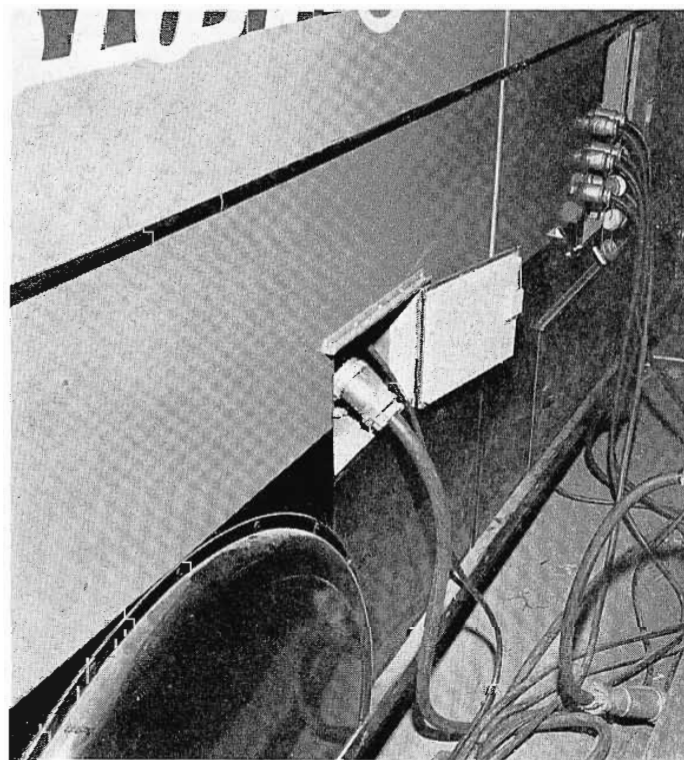
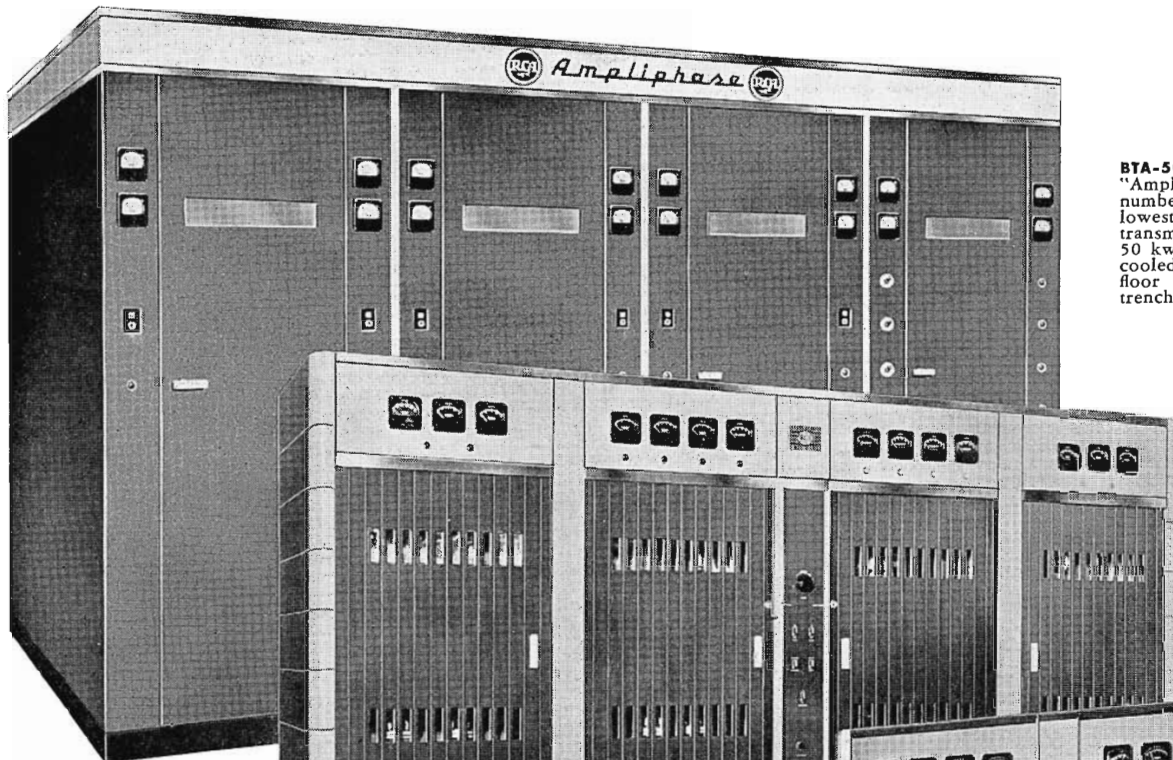
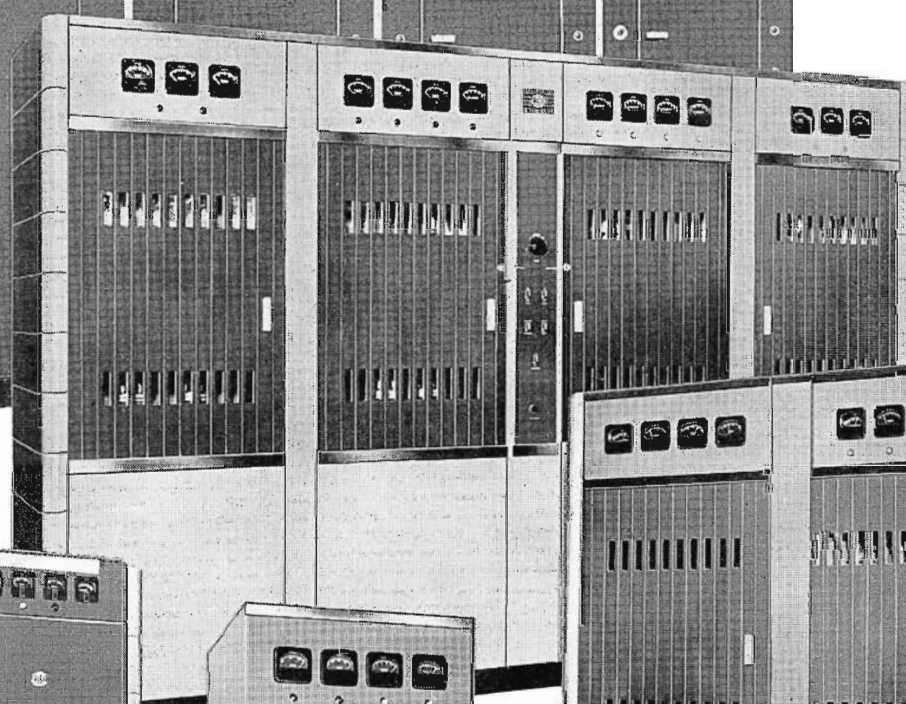

FIG. 13. Power and camera cables connected in place.



BTA-50G—50 KW AMPLIPHASE—New "Ampliphase" design greatly reduces number of tubes and power costs, assures lowest operating cost of any 50 kw AM transmitter . . . half the tube cost of older 50 kw AM transmitters. Completely air-cooled. Takes less than 80 square feet of floor space. Requires no under-floor trenches, reduces installation costs.



BTA-5H/10H—5 and 10 KW BI-LEVEL—Features "Bi-level" modulation, accomplished by adding a controlled amount of audio to the r-f driver, increases efficiency, reduces power consumption and distortion. Substantial savings in operating and tube costs combine with space-conserving design.

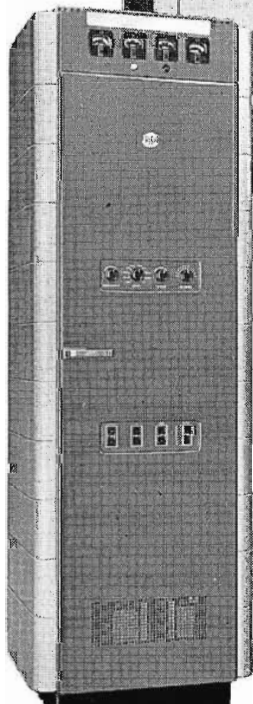

BTA-250M—250-WATT BI-LEVEL—Provides the quiet operation desirable for control room installation. Simple one-control tuning. Distortion-free "Bi-level" modulation, excellent frequency response. Uses only 10 tubes of three tube types. An ideal "economy package."

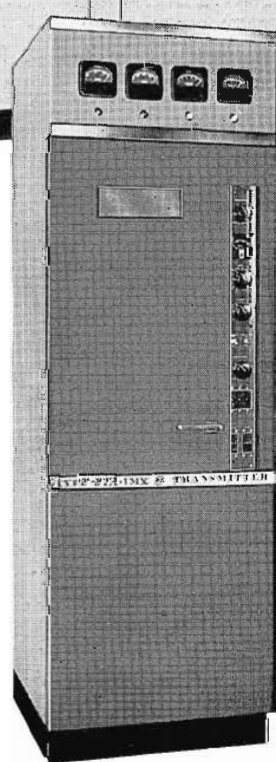

BTA-1MX/500MX—Designed for high-fidelity operation, transmitters BTA-1MX (1KW) and BTA-500MX (500 watts) offer single-control tuning, desirable Bi-level modulation, low power consumption, fewer tubes and fewer tube types. Minimum floor space required . . . approximately 6 square feet.

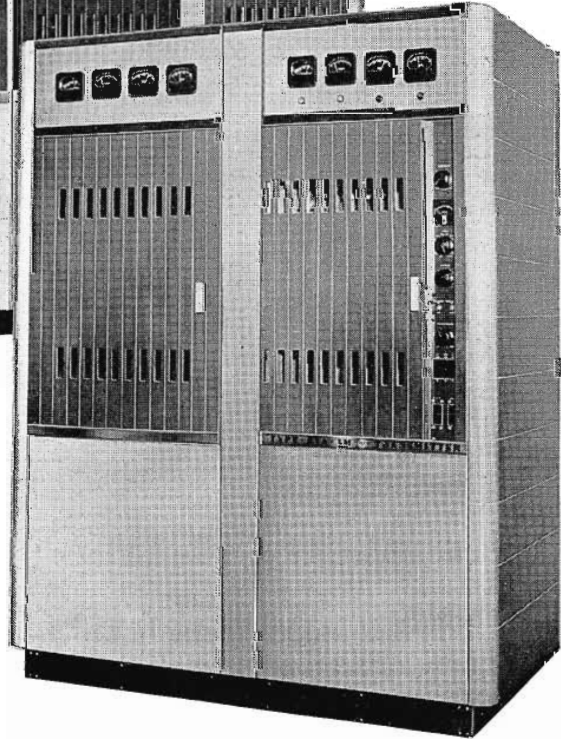

BTA-1M/500M (shown with left-wing phasing cabinet)—Features low power consumption. Uses only 15 tubes in the BTA-1M, 14 in the BTA-500M, and only four types. Single-control tuning assures ease of operation. Modulated by RCA's famous "Bi-level" technique. Complete transmitters housed in an attractive and practical light-weight aluminum cabinet.

REMOTE CONTROL EQUIPMENT—RCA Remote Control Equipment provides facilities to switch program lines, adjust plate or filament voltage, operate a line variac control on emergency transmitter, control Conelrad switching, operate power contactors and reset manual overload breakers, from any desired control point, regardless of transmitter design or power.

ANNUAL AM MEETING BRINGS RCA SALES REPRESENTATIVES TOGETHER

View Parade of Latest Products for Radio Broadcasting

On February 20 of this year our annual week-long AM Sales Meeting got under way. Each year RCA Radio Broadcast Sales Representatives from all over the country beat a path to Camden for briefings on new products and future developments in AM. A sampling of the program would include talks on: Audio Design Philosophy; New Techniques in Programming; Looking Ahead in Audio; Quality Control; Progress Report—AM Transmitters. Numerous presentations and demonstrations were given on particular products—those recently announced and others that we can't talk about just yet.

Part of the "product parade" at the sales meeting were the AM transmitters shown

out on the facing page. They represent the newest, and in every power class, the best in broadcast transmitters available today.

Three new audio consolettes featuring etched-wiring techniques and modular construction were also shown. These included: the BC-5A, a nine-input unit with four mixer positions; the BC-3B, providing facilities for thirteen inputs with eight mixer positions; and the BC-6A, incorporating nine high-level mixing channels with twenty-two inputs. All of these consolettes feature built-in power supplies.

Automatic turntable equipment excited a great deal of interest at the meeting. These BQ-101 automatic turntables offer a new concept of programming which should

prove significant during the next year. They promise to simplify "on-air" operations.

Newest in the microphone line are the BK-5A and BK-6B. A uni-directional microphone, the BK-5A is a dependable ribbon instrument giving high-quality reproduction over the entire audio range. The BK-6B is RCA's new personal microphone—a miniature instrument of the pressure-actuated type.

Shown in the group photograph on this page are a few of the RCA Broadcast Sales Representatives serving the approximately 3,000 radio stations throughout the country today. The territory that each AM Salesman serves is shown on the map on pages 64-65.

These "Pioneers" in Radio Broadcasting took some time out on the first day of the annual AM Sales Meeting to pose beside another famous pioneer—"His Master's Voice". From left to right the group includes: J. F. Palmquist, San Francisco office; A. R. Hopkins, Manager of the Broadcast and TV Equipment Dept.; E. C. Tracy, Manager of Broadcast and TV Equipment Sales; A. M. Miller, Field Sales Manager—Radio Broadcast; A. L. Malcarney, General Manager, Commercial Electronic Products; C. E. Wallack, Manager—Broadcast Audio; E. J. Meehan, Sales Administrator—Radio Broadcast; J. A. Renhard, Seattle office; B. E. Fincher, Dallas office; G. W. Darwin, Atlanta office; A. S. Timms, Boston office; V. E. Trouant, Chief Product Engineer—Broadcast and TV Dept.; J. E. Landy, Cleveland office; W. H. Keller, Atlanta office; C. L. Gardner, Kansas City office; W. K. Frank, Chicago office; D. J. Kiniry, Camden office; A. W. Power, Camden office; W. B. Valentine, New York office; J. P. Taylor, Advertising Manager, Commercial Electronic Products.

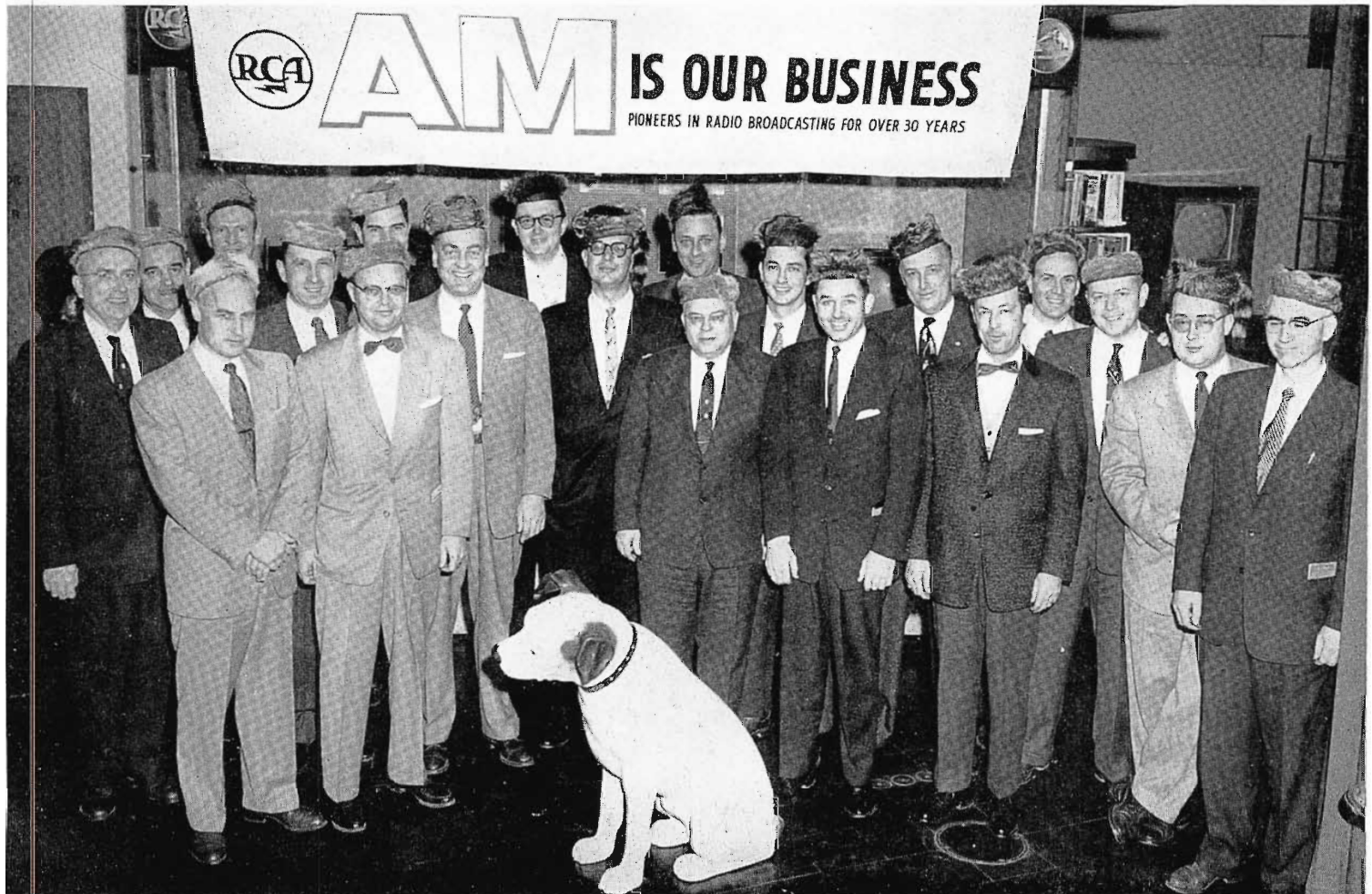

SEE YOUR NEAREST RCA BROADCAST AM

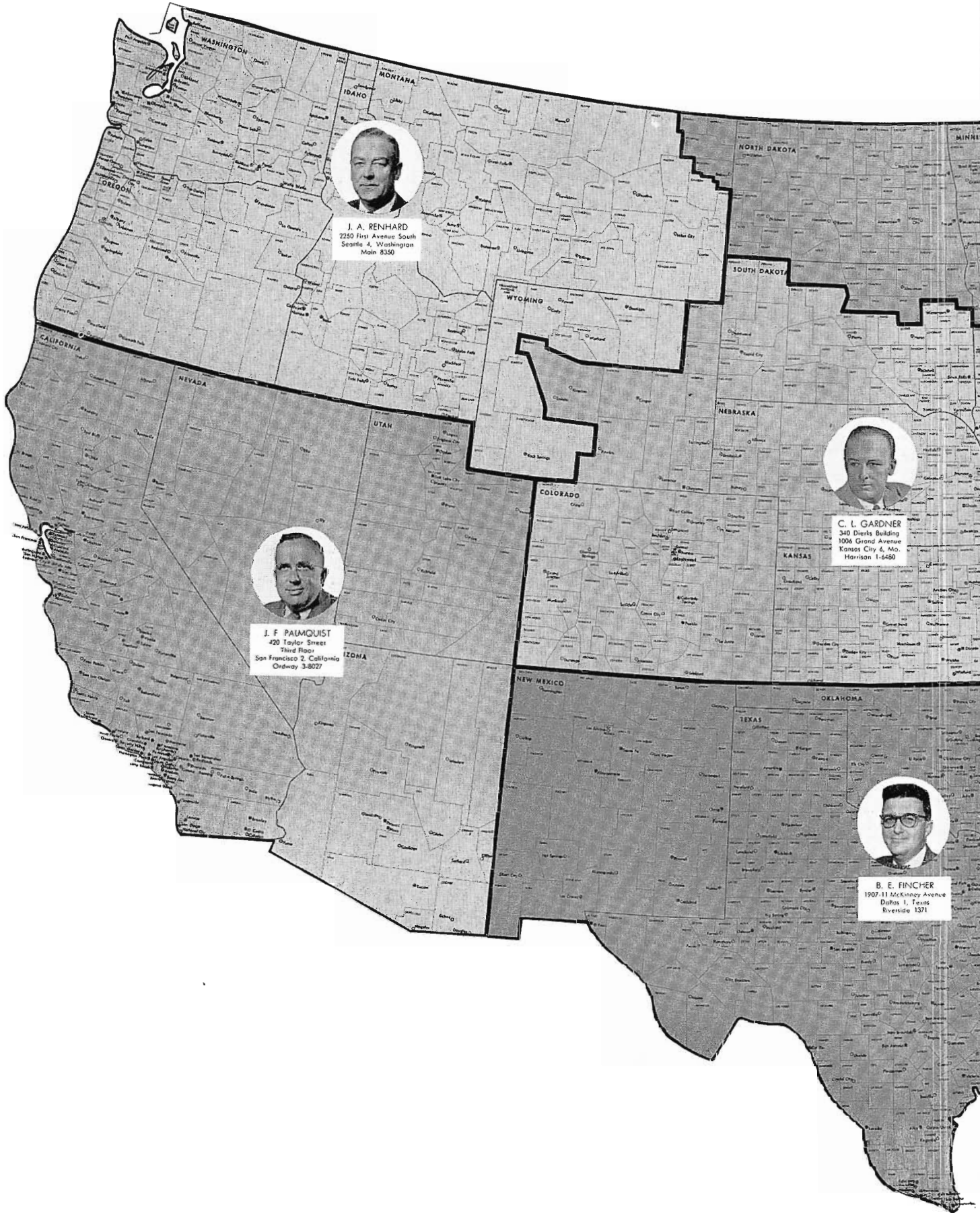

J. A. RENHARD
2250 First Avenue South
Seattle 4, Washington
Main 8350



J. F. PALMQUIST
420 Taylor Street
Third Floor
San Francisco 2, California
Ordway 3-8027



C. L. GARDNER
340 Durkin Building
1006 Grand Avenue
Kansas City 4, Mo.
Harrison 1-6480



B. E. FINCHER
1907-11 McKinney Avenue
Dallas 1, Texas
Riverside 1371

REPRESENTATIVE FOR EQUIPMENT PLANS

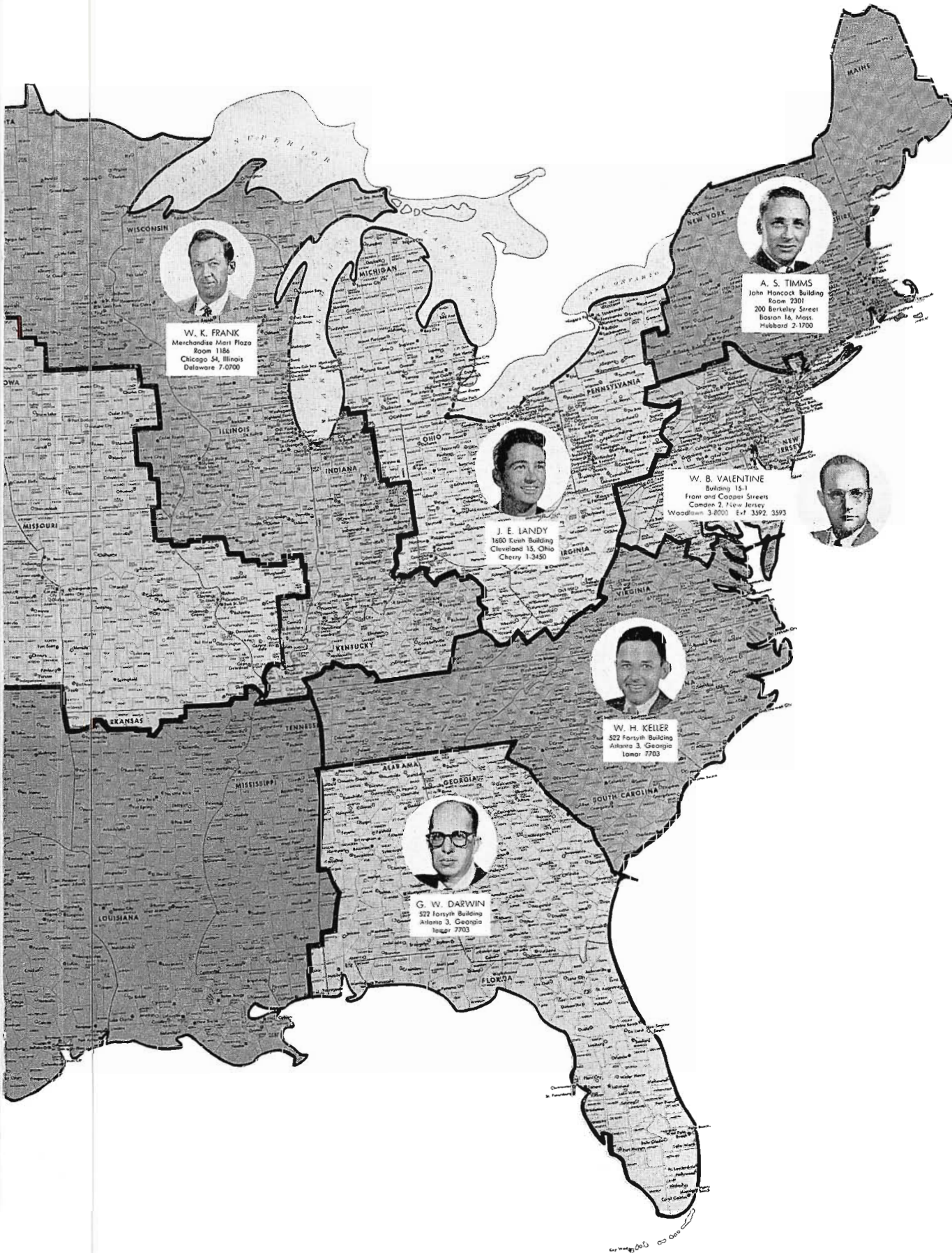

SEE YOUR NEAREST RCA BROADCAST AND TELEVISION

O. E. (ORT) WAGNER
 2250 First Avenue, South
 Seattle 4, Washington
 Telephone: Main 8350

W. G. (WOODY) EBERHART
 Merchandise Mart Plaza
 Room 1186
 Chicago 54, Illinois
 Telephone: Delaware 7-0700

R. J. (DICK) NEWMAN
 420 Taylor Street
 Third Floor
 San Francisco 2, California
 Telephone: Ordway 3-8027

E. (JACK) FROST
 1560 North Vine Street
 Hollywood 28, California
 Telephone: Hollywood 9-2154

J. S. (JOHN) ALLEN
 340 Dierks Building
 1006 Grand Avenue
 Kansas City 6, Missouri
 Telephone: Harrison 1-6460

R. E. (RALPH) SMITH
 1560 North Vine Street
 Hollywood 28, California
 Telephone: Hollywood 9-2154

E. H. (HERB) HOFF
 1907-11 McKinney Avenue
 Dallas 1, Texas
 Telephone: Riverside 1371

J. N. (JIM) BARCLAY
 1907-11 McKinney Avenue
 Dallas 1, Texas
 Telephone: Riverside 1371

REGIONAL REPRESENTATIVE FOR EQUIPMENT PLANS



F. A. (TIM) TIMBERLAKE
Merchandise Mart Plaza
Room 1186
Chicago 54, Illinois
Telephone: Delaware 7-0700



M. M. (MARSH) CARPENTER
Merchandise Mart Plaza
Room 1186
Chicago 54, Illinois
Telephone: Delaware 7-0700



D. S. (DAVE) NEWBORG
1600 Keith Building
Cleveland 15, Ohio
Telephone: Cherry 1-3450



J. R. (JOE) SIMS
John Hancock Building
Room 2301
200 Berkeley Street
Boston 16, Massachusetts
Telephone: Hubbard 2-1700



J. P. (JOE) ULASEWICZ
John Hancock Building
Room 2301
200 Berkeley Street
Boston 16, Massachusetts
Telephone: Hubbard 2-1700



R. S. (BOB) EMCH
1600 Keith Building
Cleveland 15, Ohio
Telephone: Cherry 1-3450



J. L. (JESS) NICKELS
Merchandise Mart Plaza
Room 1186
Chicago 54, Illinois
Telephone: Delaware 7-0700



J. H. (JIM) KEACHE
1600 Keith Building
Cleveland 15, Ohio
Telephone: Cherry 1-3450



A. (AU) JOSEPHSEN
36 West 49th Street
New York 20, New York
Telephone: Judson 6-3800



J. F. (FRANK) INGELS
340 Dierks Building
1336 Grand Avenue
Kansas City 6, Missouri
Telephone: Harrison 1-6480



G. F. (JERRY) RESTER
Front and Cooper Streets
Camden, New Jersey
Telephone: Woodlawn 3-8000



P. (PAUL) BERGQUIST
1625 "K" Street, N.W.
Washington, D.C.
Telephone: District 7-1260



J. W. (JOHN) HILLEGAS
522 Forsyth Building
Atlanta 3, Georgia
Telephone: Lamar 7703



W. D. (WILEY) WENGER
1907-11 McKinney Avenue
Dallas 1, Texas
Telephone: Riverside 1371



P. G. (PG) WALTERS
522 Forsyth Building
Atlanta 3, Georgia
Telephone: Lamar 7703



M. R. (MILT) NORTON
1907-11 McKinney Avenue
Dallas 1, Texas
Telephone: Riverside 1371



J. M. (JOE) WALTERS
522 Forsyth Building
Atlanta 3, Georgia
Telephone: Lamar 7703

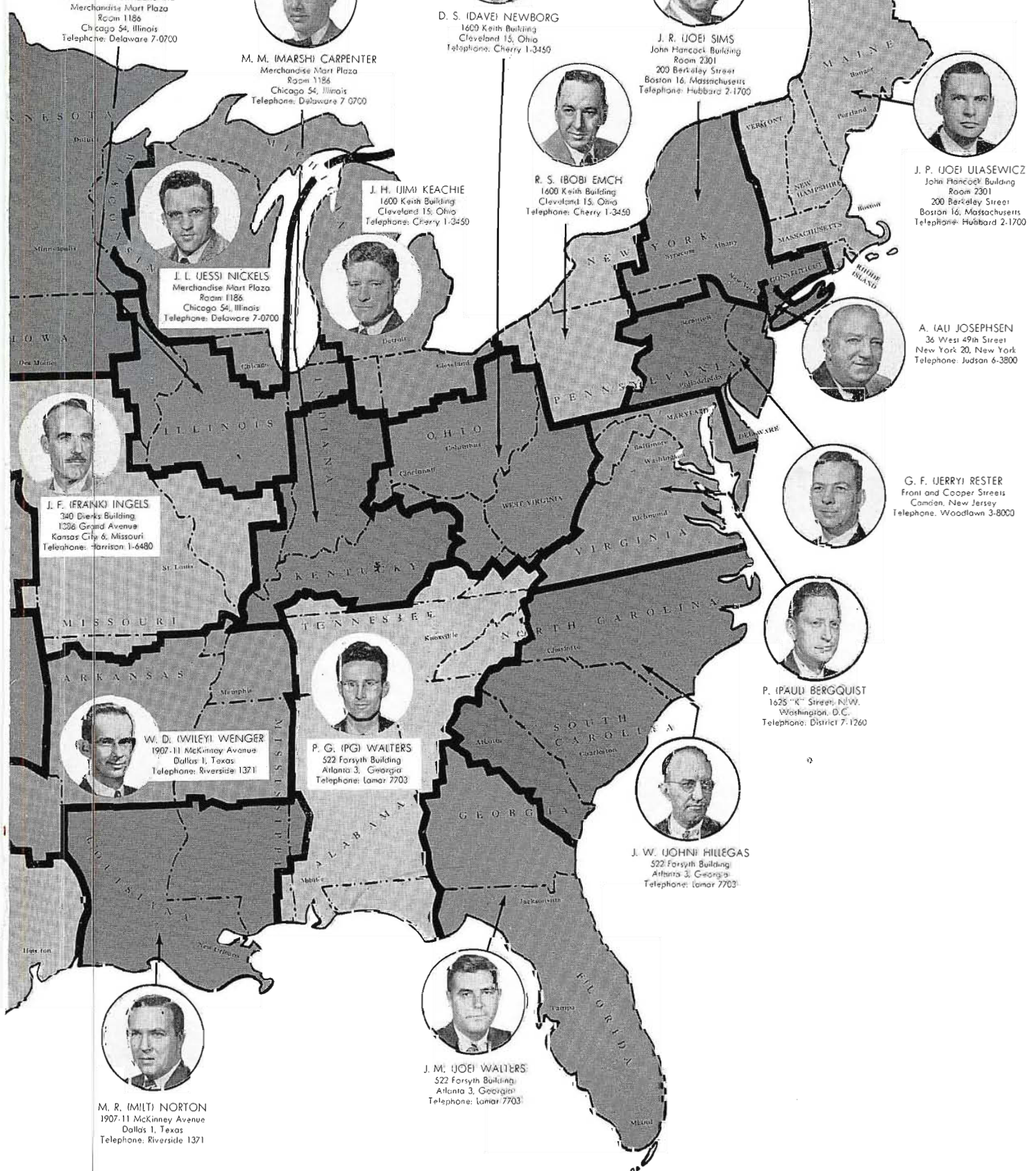

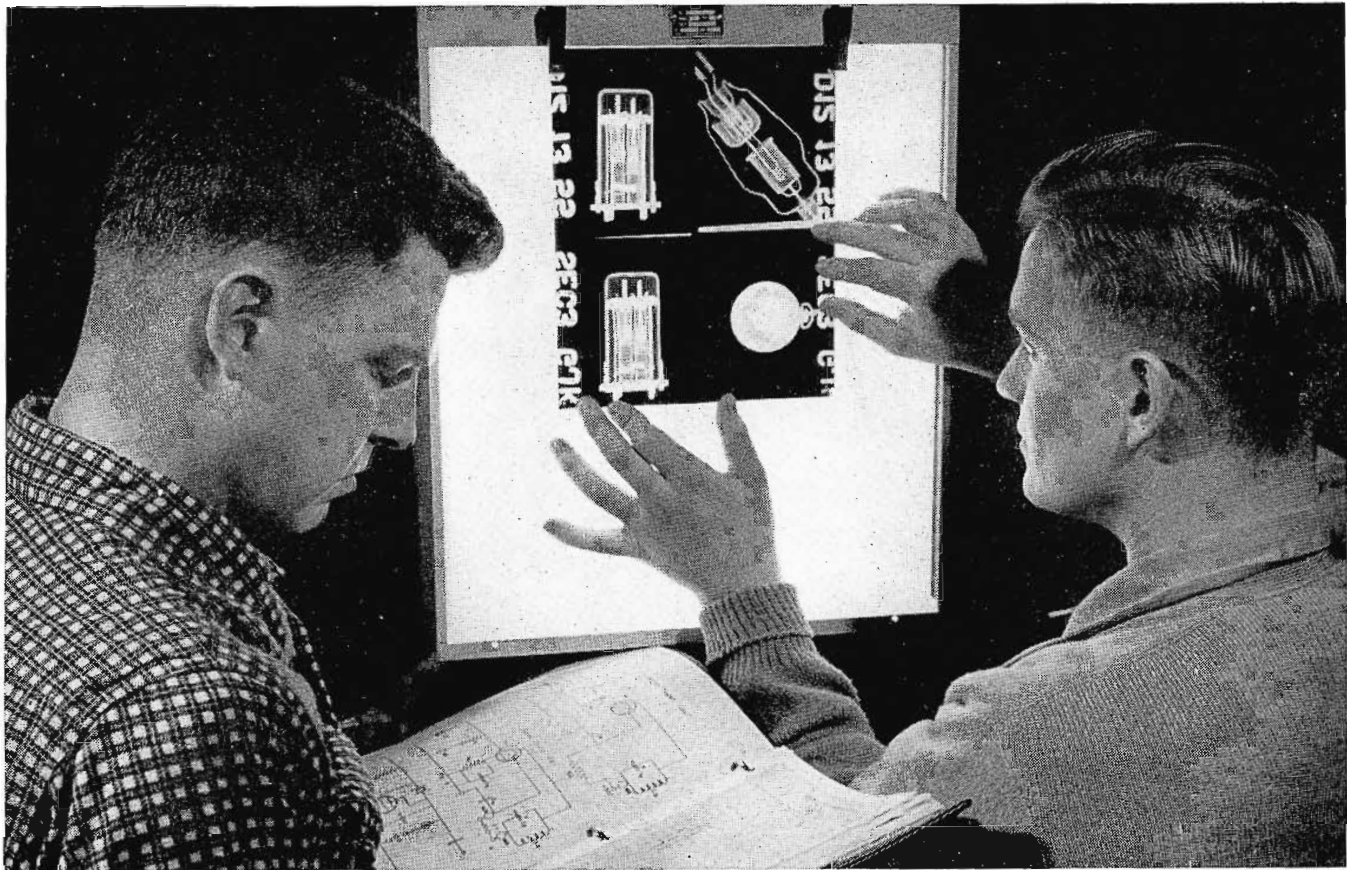

Students inspecting X-ray of vacuum tube in the Industrial Electronics Laboratory

See for yourself... RCA Institutes gives AUTHORITATIVE TRAINING in electronics!

RCA INSTITUTES graduates really know what happens inside electron tubes and equipment. Courses are comprehensive in subject coverage. Instructors have years of field-experience as engineers, technicians, and teachers. This assures the most authoritative training—in a school devoted exclusively to electronics—helps prepare the student for further advancement in the field.

RCA Institutes started its first small classes in 1909 and today provides the electronic industry with large numbers of trained personnel in development and design, maintenance and operation.

SCHOLASTIC RECOGNITION

RCA Institutes is...licensed by the University of the State of New York...an affiliate member of the American Society for Engineering Education...an affiliate member of the Greater New York Council for Foreign Students...approved by the Veterans Administration. The Advanced Technology Course is approved by the Engineers' Council for Professional Development.

The Advanced Technology Course consists of 2565 hours of classroom and laboratory work. It requires two and a quarter years (49 weeks per year) in the day school, or six and three-quarter years in the evening school. Subject treatment is at professional level; the textbooks are standard college and engineering texts. This course covers such subjects as...college physics...mathematics through differential

equations...English in industry...circuit design for television receivers, transmitters and studio equipment. The course omits purely academic and cultural subjects so that competent technologists may be trained in the shortest possible time. The Advanced Technology Course is especially attractive to...high school graduates...engineering school graduates wishing a more specialized knowledge of the radio-television field...junior college graduates seeking a superior technical-school preparation for entrance into the radio-television industry.

VOCATIONAL COURSES

RCA Institutes also offers shorter, specialized courses in...Television and General Electronics (1½ years, days; or 4½ years, evenings)...Television and Radio Servicing (9 months, days; or 27 months, evenings). Subject treatment is at the technician's level; based on high school mathematics. A minimum of two years high school education is required for admission.

INDUSTRIAL ELECTRONICS

Increased attention is given in the principal courses to the growing importance of

Industrial Electronics, pertaining to control, treatment and measurement in industrial processes. A special laboratory is devoted to typical application of electronics such as electron microscope...X-ray machine...precipitron...recording potentiometer...servo controls and radio frequency heating.

HOME STUDY COURSES

Three correspondence courses are offered...Radio-TV Electronics Course for the beginner...TV Servicing Course for those having basic knowledge of radio...Color TV Course for those having basic knowledge of television.

GENERAL INFORMATION

New classes in all resident courses are started four times each year. Day classes meet Monday through Friday; evening classes meet on alternate evenings. Prospective students and employers are invited to visit classrooms and laboratories of the school, or to write for free descriptive catalog of courses. Prospective students may enroll in Home Study Courses at any time...free literature will be mailed upon request.



RCA INSTITUTES, INC.

School of Television and Electronic Technology

A SERVICE OF RADIO CORPORATION OF AMERICA

350 WEST FOURTH STREET, NEW YORK 14, N. Y.

For Export . . .

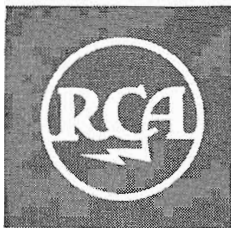

RCA's new design sets Tomorrow's standard for radio telegraph transmitters

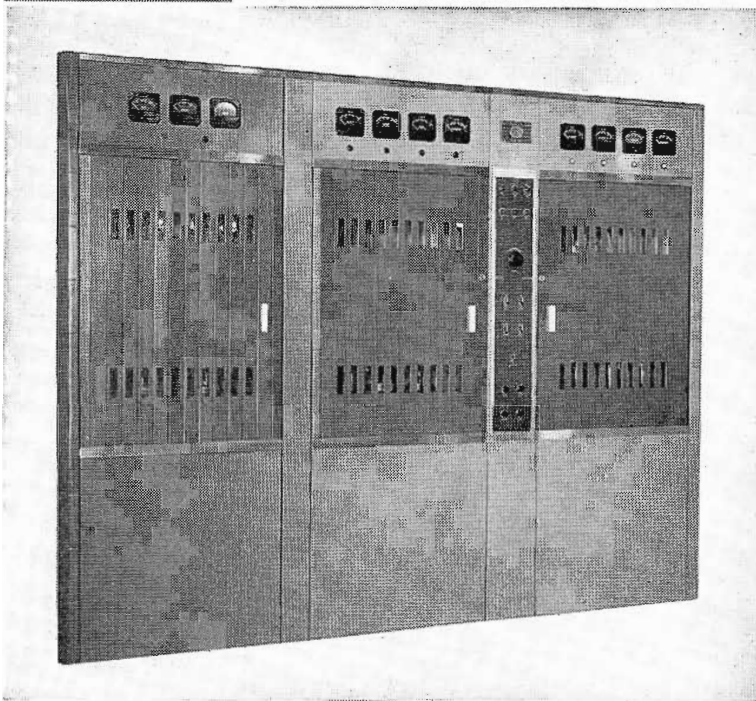

★ **SAVE MONEY** on personnel training — extremely simple to operate.

★ **SAVE MONEY** on installation — self-contained, factory-wired unit.** Occupies smallest possible space. Building alterations unnecessary.

★ **SAVE MONEY** on operation. Tube, power and depreciation costs are extremely low.

NEW RCA ET-18 15KW radiotelegraph transmitter uses latest multigrad tubes for self-neutralization. Ideal harmonic suppression (no interference with TV or other signals); exceptional circuit stability.

Revolutionary Advance in Frequency-Shift Telegraphy — RCA's years-ahead ET-18 15KW transmitter — efficient, reliable, versatile. A modulator is available to convert it for 10KW broadcasting, AM telephony, or single sideband telephone and telegraph transmission. The ET-18 provides full power output over the entire 3.2 to 24 mc range. There are only three radio-frequency power stages between the 2-watt frequency-shift keyer and full power output; and all power amplification is at operating frequency.

****Lowest cost.** Self-contained and factory-

wired except for one external power transformer, the entire unit occupies only 25.8 sq. ft. of floor space — may be located in existing building without expensive alterations. With minimum instruction, non-technical personnel can operate the ET-18. It requires attention only when frequency is to be changed. And the total number of components has been decreased, reducing your replacement problems. Difficult-to-service mechanisms have been eliminated.

As a long-range investment, the ET-18 has no peer. For complete information, see your RCA distributor or write:



RCA INTERNATIONAL DIVISION

RADIO CORPORATION of AMERICA

RCA BUILDING

30 ROCKEFELLER PLAZA, NEW YORK N. Y., U. S. A.

MARCA(S) REGISTRADA(S)
TRADEMARK(S) REGISTERED

BTA-5H!

Newest

with 6 Major

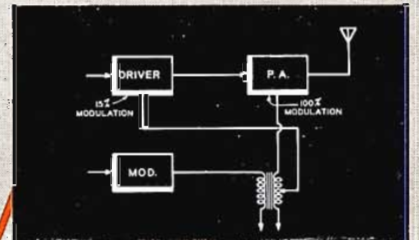

1. Bi-Level Modulation improves linearity and fidelity . . . saves power.

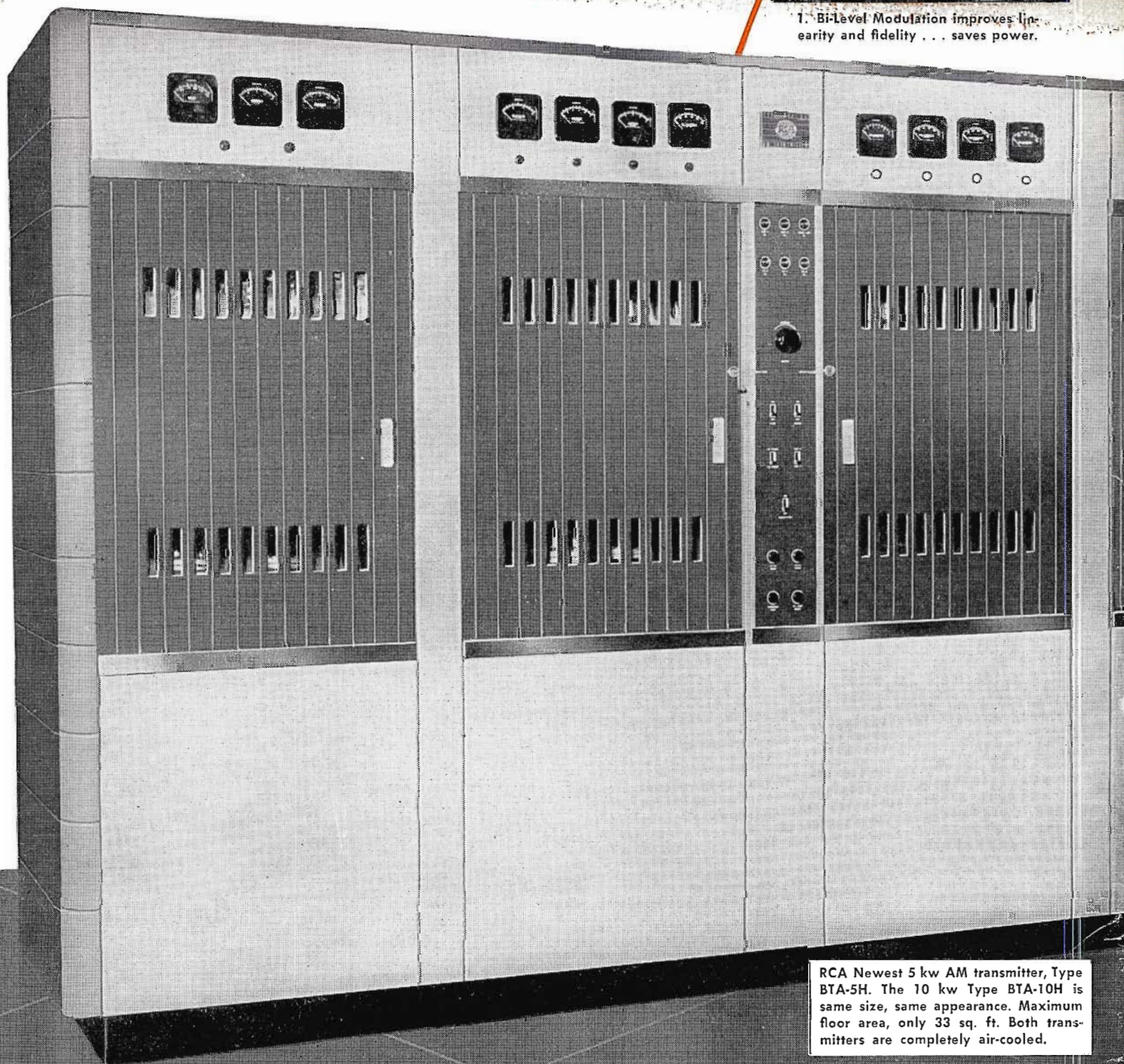

RCA Newest 5 kw AM transmitter, Type BTA-5H. The 10 kw Type BTA-10H is same size, same appearance. Maximum floor area, only 33 sq. ft. Both transmitters are completely air-cooled.

RCA 5-KW "AM"

Benefits, Including Bi-Level Modulation

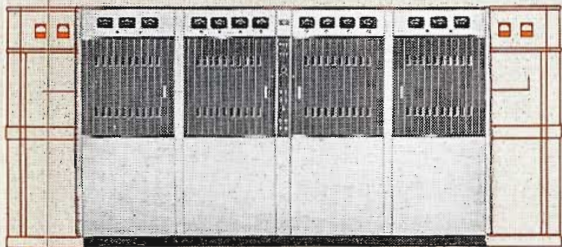

2. Up to 40% less floor area than previous "5 kw's"

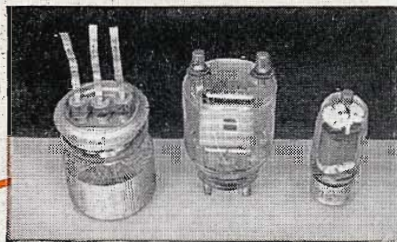

3. Power tube costs reduced



4. 1/60th second arc-back protection

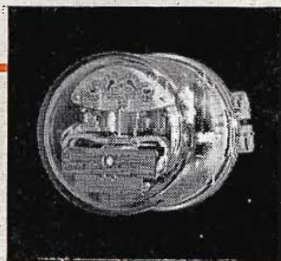

5. Lower power bills



6. Sliding doors—front and rear

Just read these exclusive features . . .

- 1 Bi-level modulation, accomplished by adding a controlled amount of audio to the r-f driver increases efficiency, reduces power consumption and reduces distortion. Linearity of the power amplifier is greatly improved by varying the drive in proportion to the modulation.
- 2 BTA-5H requires less "operating" floor space than other 5 kw's—saves up to 40% floor area. Entire transmitter is only 84" high, 130" wide, 32½" deep.
- 3 BTA-5H is the only "5 kw" with such low tube costs. Power and modulator stages use the new small size, lightweight RCA-5762—costing less than half that of power types in most "5 kw's."
- 4 It's the ONLY "5kw" with "split-cycle" overload and voltage protection—using thyatron-controlled rectifiers. Circuits work so fast audiences cannot detect "off-air" breaks.
- 5 BTA-5H holds power bills to the LOWEST in the "5-kw" field through smaller power tubes, fewer stages, fewer tubes (only 23 tubes and 7 different types).
- 6 BTA-5H is equipped with horizontally-sliding doors front and back. Benefits:
 - ✓ Saves over 60 square feet of floor area
 - ✓ Provides more elbow room for operator
 - ✓ Makes it easier to get at transmitter.

For all the facts about this new 5 kw transmitter . . . call your nearest RCA Sales Representative. Also ask for bulletin B.6535 shown at right.



RADIO CORPORATION of AMERICA
ENGINEERING PRODUCTS DEPARTMENT

CAMDEN, N.J.

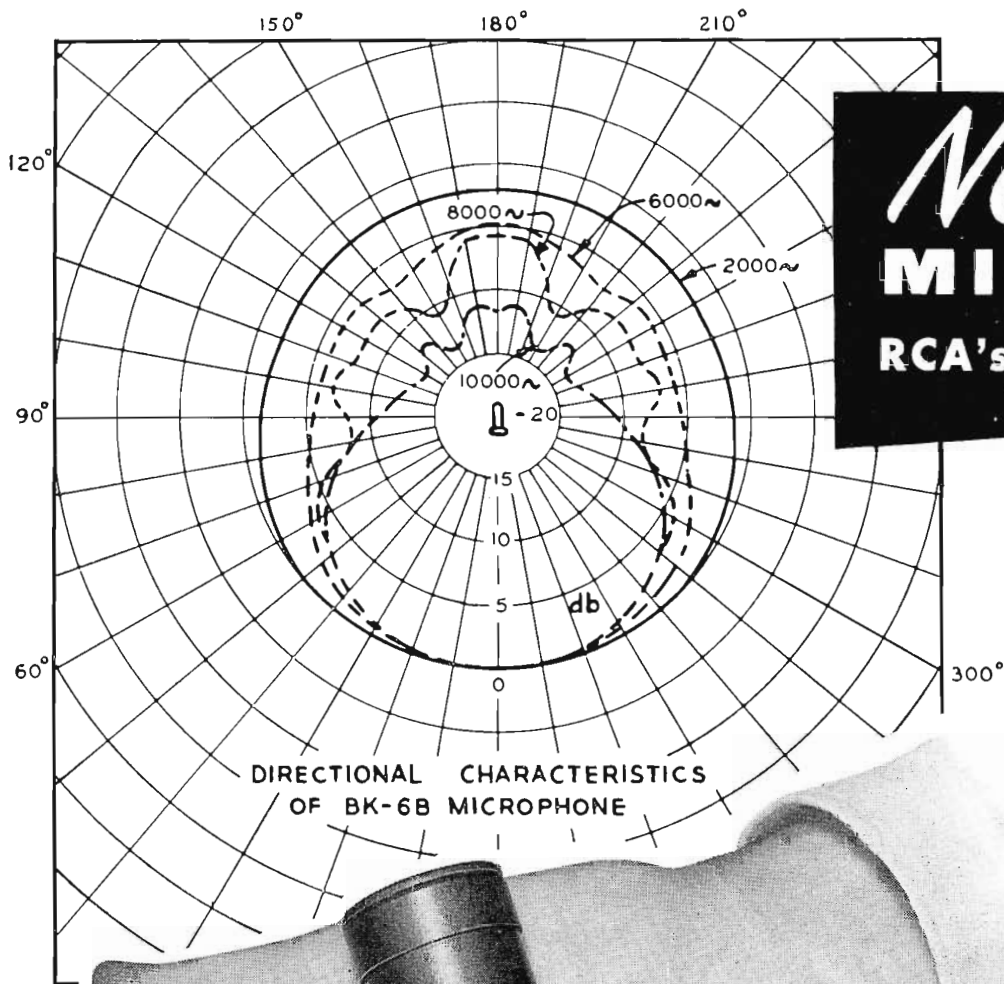

New PERSONAL MICROPHONE

RCA's BK-6B Miniature Mike

- Half the size (by volume) of the BK-6A!
- Excellent speech balance when talking "Off Mike!"
- Wide range Frequency Response!

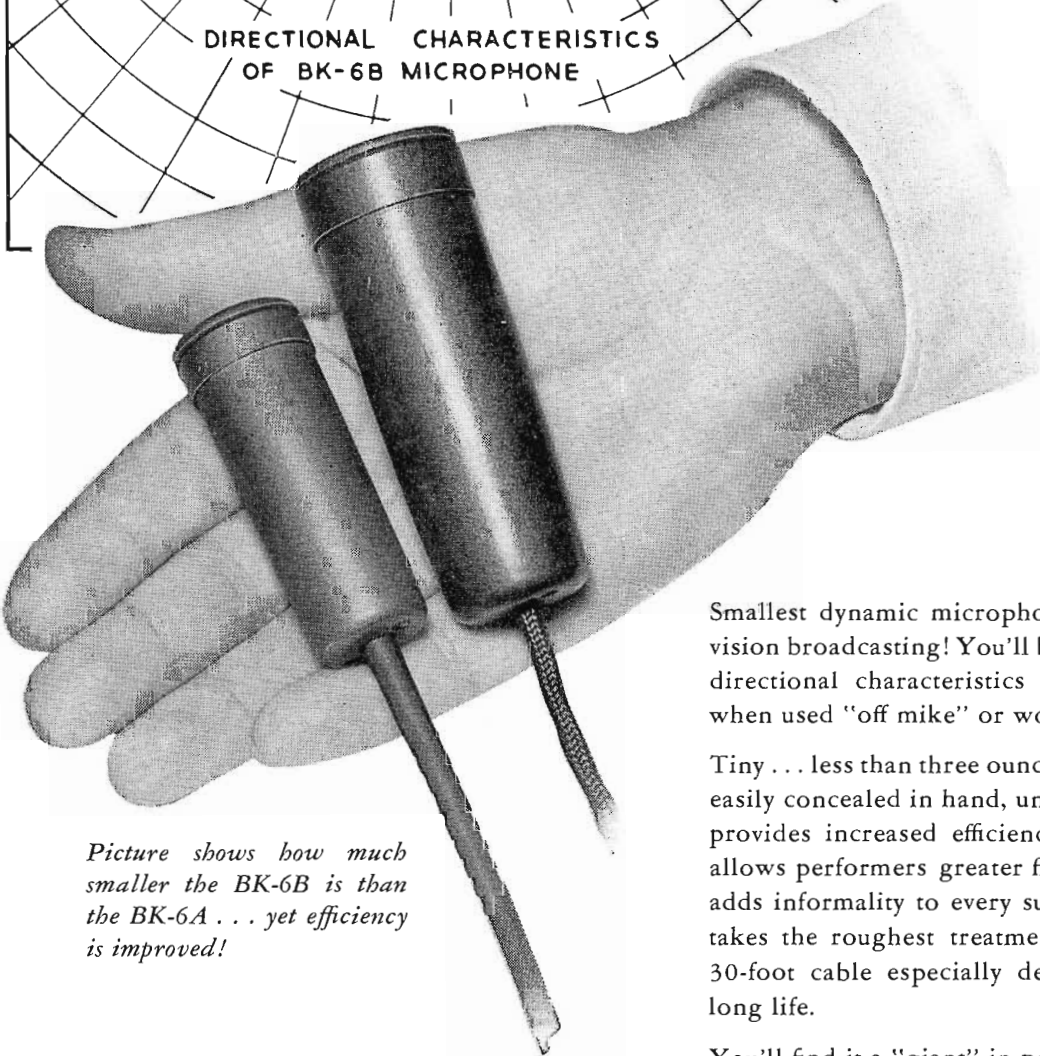

Picture shows how much smaller the BK-6B is than the BK-6A . . . yet efficiency is improved!

Smallest dynamic microphone ever developed for radio and television broadcasting! You'll be amazed by its frequency response and directional characteristics that provide superior speech balance when used "off mike" or worn on the person.

Tiny . . . less than three ounces in weight, this new miniature mike is easily concealed in hand, under necktie, or corsage. Versatile . . . it provides increased efficiency to difficult walk-around operations, allows performers greater flexibility and freedom of movement . . . adds informality to every such production. Tough . . . the BK-6B takes the roughest treatment in stride, is furnished with flexible 30-foot cable especially designed for ease of manipulation and long life.

You'll find it a "giant" in performance for a wide variety of broadcast applications. Ask your RCA Broadcast Representative for complete information. In Canada, write RCA VICTOR Company Ltd., Montreal.



RADIO CORPORATION of AMERICA
 BROADCAST AND TELEVISION EQUIPMENT
 CAMDEN, N. J.

NOW—11 KW

...with RCA's TT-10AL

for VHF

With recent design advances, RCA engineers have increased the power output of the TT-10AL VHF transmitter. This popular transmitter now delivers a full 11 KW of peak visual power (low band)—measured at the output of the sideband filter. If you need this extra KW, it's yours now.

Costs no more than the original 10-KW design—and of course it can handle color.

With power increased to 11 KW, RCA's exclusive TT-10AL—in combination with an RCA 12-section antenna—is the most

outstanding VHF system in the industry, delivering 100 KW ERP at the lowest operating cost of any VHF equipment package now available.

RCA 11 kilowatters are ready to ship. Order yours now for early delivery. For complete details, see your RCA Broadcast Sales Representative. In Canada, write RCA VICTOR Company Ltd., Montreal.

Ask your Broadcast Sales Representative for literature describing RCA's new 11-KW design for channels 2 to 6.

RCA Pioneered and Developed Compatible Color Television



**For Color
or Monochrome**



RADIO CORPORATION of AMERICA
ENGINEERING PRODUCTS DEPARTMENT

CAMDEN, N.J.



At a noted New York hospital, new RCA color camera telecasts an operation. Equipment is completely out of doctors' way.

Now RCA Color TV helps doctors of tomorrow give you better surgical care

No longer must interns in a surgical amphitheater squint for a peek at the patient on the operating table below.

With the new, compact RCA color TV system developed specifically for medical use, students in other parts of the hospital can now see vivid close-ups of operations on standard color receivers. They can study enlargements of pathological slides that often determine the course of surgery. And what they learn today, of course, will enable them to give you better care tomorrow.

Ultimately, this same RCA compatible color TV system may be used to establish a nationwide network of specialists for on-the-spot consultation and diagnosis.

Here is another milestone in electronics from RCA, the pioneer that made it possible for you to see exciting color and black-and-white programs on the same set. And continually, RCA scientists at the David Sarnoff Research Center, Princeton, N. J., search for new horizons of "Electronics for Living"—electronics to make life easier, safer, happier.



RADIO CORPORATION OF AMERICA
ELECTRONICS FOR LIVING

Fight Cancer with a Checkup . . . and a Check

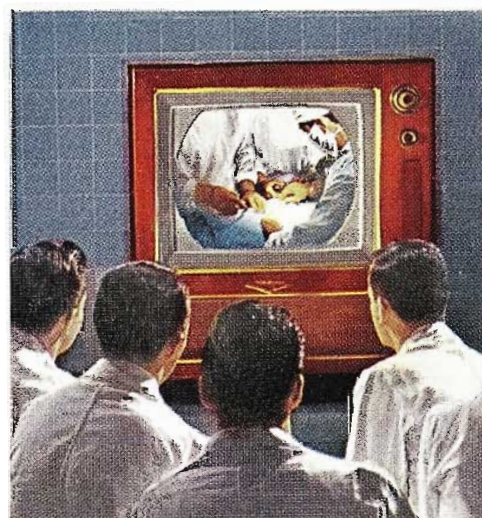

In other parts of hospital—or hundreds of miles away—medical students see close-ups of operation on Big Color RCA Victor TV. Shown above: "Director 21" model with full 250 sq. in. of viewable picture.